

Operations Manual

OM-001-03000-00-04.1

APS - 3000 Series Power Converters



ADAPTIVE Power Systems

Worldwide Supplier of Power Conversion Equipment

Contents

Front Matter

Contents	ii
Contact Information.....	v
Warranty Information.....	vi

Chapter 1 Introduction

Introduction.....	1-1
Overview	1-1
Safety Notices	1-2
Preparation for Installation.....	1-5
Installation Instructions	1-6
Example Wiring Diagram	1-7
Storage and Transportation	1-8

Chapter 2 Specifications

Overview	2-1
Introduction	2-2
APS-3000P Specifications	2-2
Input Electrical Specifications	2-3
Output Electrical Specifications	2-3
Power versus Output Frequency Rating Chart	2-4
Displays and Controls	2-5
Mechanical Specifications	2-5
Environmental Specifications	2-5
Output Surge-Current Capability	2-6

Chapter 3 Unit Description

Overview	3-1
Front Panel Organization	3-1
Frequency Display and Selection	3-3
Voltage Display and Selection	3-4
Current Display and Selection	3-5
Multimeter Display and Selection	3-6
Cabinet Controls and Connections	3-7
Chassis Details	3-7
Cabinet Features	3-9

Chapter 4 Operating Instructions

Overview	4-1
Basic Operation	4-2
System Parameter Settings.....	4-9
System Parameter Table.....	4-10
Setting System Parameters (Programming)	4-11
Program Parameter Settings	4-13
Program Parameter Table.....	4-13
Setting Program Parameters (Programming)	4-14
Error Messages	4-15
Error Message Table	4-16
Interpreting Error Messages.....	4-17

Chapter 5 External Interfaces

Overview	5-1
PLC External Interface	5-2
Manual Switcher (Three-Program Control)	5-3

Chapter 6 System Calibration

Overview	6-1
Calibration Setup	6-2
Calibration Instructions	6-4
Low-Voltage Mode (V-LO) Calibration	6-6
High-Voltage Mode (V-HI) Calibration	6-7
Low-Current Mode (A-LO) Calibration	6-8
High-Current Mode (A-HI) Calibration	6-10
Low-Power Mode (P-LO) Calibration	6-12
High-Power Mode P-HI) Calibration.....	6-14

Chapter 7 System Maintenance

Overview	7-1
Introduction	7-1
System Design	7-2
APS-3000 Series System Block Diagram.....	7-4

Contact Information

Adaptive Power Systems, Inc.

17711 Mitchell North • Irvine, CA 92614 USA

Telephone: (949) 752-8400

FAX: (949) 756-0838

E-mail: sales@adaptivepower.com

Web: <http://www.adaptivepower.com>

APS-3000 Series Power Converters Limited Warranty

Adaptive Power Systems, Inc. (APS) warrants each unit to be free from defects in material and workmanship. For the period of one (1) year from the date of shipment to the purchaser, APS will either repair or replace, at its sole discretion, any unit returned to the APS factory in Irvine, California. It does not cover damage arising from misuse of the unit or attempted field modifications or repairs. This warranty specifically excludes damage to other equipment connected to this unit.

Upon notice from the purchaser within (30) days of shipment of units found to be defective in material or workmanship, APS will pay all shipping charges for the repair or replacement. If notice is received more than thirty (30) days from shipment, all shipping charges shall be paid by the purchaser. Units returned on debit memos will not be accepted and will be returned without repair.

This warranty is exclusive of all other warranties, expressed or implied.

APS-3000 Series Service and Spare Parts Limited Warranty

APS warrants repair work to be free from defects in material and workmanship for the period of ninety (90) days from the invoice date. This *Service and Spare Parts Limited Warranty* applies to replacement parts or to subassemblies only. All shipping and packaging charges are the sole responsibility of the buyer. APS will not accept debit memos for returned power sources or for subassemblies. Debit memos will cause return of power sources or assemblies without repair.

This warranty is exclusive of all other warranties, expressed or implied.

Chapter 1

Introduction

Chapter 1 - Introduction

Chapter 1 contains important information you should read BEFORE attempting to install and power-up your APS-3000 Series Power Converter. The information in this chapter is provided for use by experienced operators. Experienced operators understand the necessity of becoming familiar with, and then observing, life-critical safety and installation issues. Topics in this chapter include:

- Safety Notices
- Warnings
- Cautions
- Preparation for Installation
- Installation Instructions
- Transportation
- Storage

Introduction to the APS-3000 Power Converter

APS-3000 Series Power Converters have been designed for long-life trouble-free operation in the shop-floor testing environment. The input to APS-3000 units is commercially available power at fixed voltage and frequency. The output from APS-3000 units is programmable power at user-controlled voltages and frequencies.

There are several operational modes: (1) front panel manual control; (2) manually-programmed test sequences; and (3) externally-controlled manually-programmed test sequences. All units have the ability to be externally controlled by remote switch closures.

The APS-3000 Series of Power Converters have been designed to provide frequency and voltage conversion in a controlled test environment. All APS-3000 Series Power Converters provide 3-phase output power. Different APS models cover the power range from 3 kVA to 180 kVA. All units provide user-controlled 3-phase output power within the frequency range of 45 – 500 Hz.

All APS-3000 Series units operate as double-conversion power converters. The first conversion is AC to DC. The second conversion is DC back to AC. All units (except the 1-phase input APS-3003 and APS-3006) operate with 3-phase input power. After rectification, filtering removes high-frequency content. Low-ripple DC is subsequently converted to 3-phase AC by a high-frequency pulse-width-modulated (PWM) switcher. Precise control is maintained by using a highly stable digital oscillator.

APS-3000 Series Power Converters are designed for long-term continuous operation in sheltered (no rain) environments. Because there are no batteries, APS-3000 units operate reliably over a wide ambient temperature range. Through the use of switching technology the equipment is efficient (about 85%). Power Converter units are relatively tolerant of high dust environments.

Safety Notices

- APS-3000 Series Power Converters can transfer very large amounts of electrical energy very quickly.
- The rapid transfer of large amounts of electrical energy is fundamental to any high-performance power source.
- **Only experienced operators who have both read and understood the information in this manual should attempt to operate the unit.**
- The following warnings and cautions herein must be observed at all times.

WARNINGS indicate potentially hazardous situations which, if not avoided, could result in death or serious injury. All warnings throughout this manual will appear as follows:

WARNING

**THIS EQUIPMENT CONTAINS HIGH ENERGY, LOW IMPEDANCE CIRCUITS!!
LETHAL POTENTIALS ARE CONTAINED WITHIN THE CABINET.**

**CARE MUST BE EXERCISED WHEN OPERATING, CALIBRATING, OR SERVICING
THIS EQUIPMENT, IN ORDER TO PREVENT SERIOUS OPERATOR INJURY OR
EQUIPMENT DAMAGE.**

OBSERVE THE FOLLOWING WHEN SERVICE AND MAINTENANCE ARE REQUIRED:

- 1) REMOVE ALL JEWELRY FROM ARMS AND NECK WHEN SERVICING THIS EQUIPMENT. THIS PREVENTS THE POSSIBILITY OF SHORTING THROUGH THE JEWELRY AND CAUSING BURNS TO THE OPERATOR.**
- 2) WEAR SAFETY GLASSES WHEN SERVICING THIS EQUIPMENT TO PREVENT EYE INJURY DUE TO FLYING PARTICLES CAUSED BY ACCIDENTAL SHORT CIRCUIT CONDITIONS.**
- 3) DO NOT REMOVE ANY PANEL OR COVER WITHOUT FIRST REMOVING THE INPUT POWER BY OPENING ALL CIRCUIT BREAKERS.**
- 4) SERVICE OTHER THAN REGULARLY SCHEDULED CALIBRATION OR EXTERNAL CLEANING SHOULD BE REFERRED TO PERSONNEL AUTHORIZED BY THE FACTORY TO SERVICE THIS EQUIPMENT.**

WARNING

**IF THIS EQUIPMENT IS NOT USED IN A MANNER SPECIFIED BY THE MANUFACTURER,
THE PROTECTION PROVIDED BY THE EQUIPMENT MAY BE IMPAIRED**

CAUTIONS indicate a potentially hazardous situation which, if not avoided, may result in minor or moderate injury. It also may be used to alert against unsafe practices. Cautions will appear as shown below. All cautions should be rigorously observed.



To protect the equipment from damage, caution statements are used as follows:

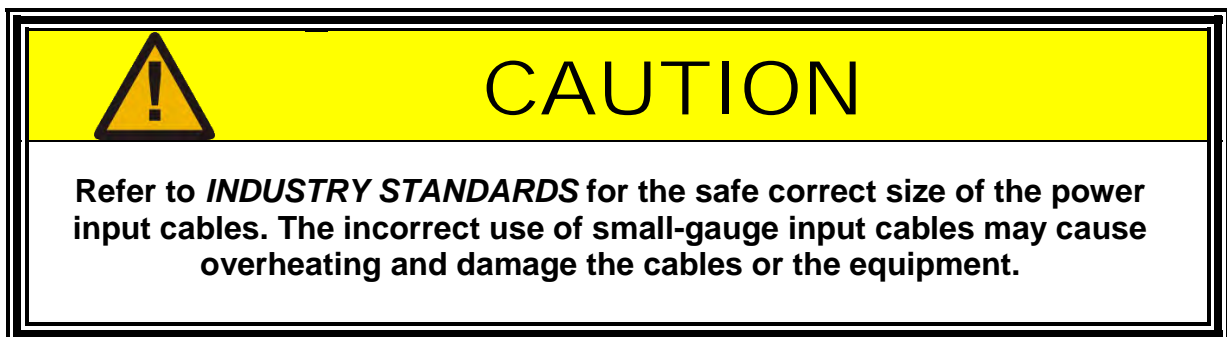

- Before using this AC converter, please read all the safety labels that are attached to this unit.
- Before turning on the input power source to this equipment, please check to make sure that the input voltage selection is correct.



Preparation for Installation

Important Information and Instructions

This section contains instructions for unpacking, inspecting, preparing and storing your APS-3000 Power Converter.

Unpacking and Inspection

APS-3000 Power Converters are well packed to provide protection in the normal shipping environment. If the shipping box appears damaged upon receiving, please inspect the power source for scratches or damage. If the product has been damaged, please alert the freight company and contact APS or the distributor. Please keep the original box and packing to assist in determining how the damage occurred.

What to do if Damage has Occurred

If your APS-3000 Power Converter was damaged in shipment, you must file a damage claim with the freight company. Do not return the product before contacting APS to receive a Returned Merchandise Authorization (RMA) number.

Please retain all the original packing materials. If the APS-3000 Power Converter must be sent back for repair, use the original packing materials for packing.

Installation Instructions

Input and Output Circuit Breakers

APS-3000 Power Converter input and output circuit breakers and their connections are on the rear of the unit. Please check to make sure all wires are connected correctly and secured. Cooling fans, located at the sides and rear of the unit, provide air circulation for cooling and heat removal.

Note: It is also important to position the unit to allow easy access to the circuit breakers on the rear of the unit.

A typical wiring diagram is shown on the following page.

AC Line Input Current Requirements

The AC input requirement for the APS Power Converter depends on the configured AC input voltage and total power level of the specific APS 3000 model. For three phase AC input models, the current shown in the table below is for each phase.

Input wire sizes must be chosen to support the maximum currents shown in this table and must conform to local electrical safety codes.

AC Line Input Current Requirements											
Model		3003	3006	3009	3015	3030	3060	3090	3120	3150	3180
Input Phase		1-phase / 2-wire + GND		3-phase							
Rated Power	Total Power	3 KVA	6 KVA	9	15KVA	30KVA	60KVA	90KVA	120KVA	150kVA	180kVA
	Per Phase	1 KVA	2 KVA	3	5 KVA	10KVA	20KVA	30KVA	40KVA	50kVA	60kVA
Phase	230V, 1 ϕ	20 A	40 A	-	-	-	-	-	-		
	208V, 3 ϕ	-	-	40 A	60 A	125 A	250 A	400 A	500 A		
	220V, 3 ϕ	-	-	40 A	60 A	125 A	250 A	350 A	500 A		
	240V, 3 ϕ	-	-	30 A	50 A	100 A	225 A	300 A	400 A	500 A	
	380V, 3 ϕ	-	-	20 A	40 A	75 A	150 A	200 A	300 A	375 A	450 A
	415V, 3 ϕ	-	-	20 A	30 A	60 A	125 A	200 A	250 A	300 A	375 A
	480V, 3 ϕ	-	-	15 A	30 A	50 A	125 A	175 A	225 A	250 A	375 A

Input Voltage Requirement and Selection

APS-3000 Series Power Converters are delivered with a universal input transformer. You will receive your unit factory-connected and tested at the voltage specified at the time of order. Please check the unit data plate to verify the voltage is correct.

Operating Environment

APS-3000 Series Power Converters are designed to operate reliably over a wide range of environmental conditions. Please operate within the following limits:

- Temperature: 0 °C – 40 °C (32 °F – 104 °F)
- Humidity: 20% – 80% (Non-condensing)
- Altitude: Below 2,000 meters (6,500 feet) of elevation

Example Wiring Diagram

INPUT / OUTPUT Power Panel at Rear of APS Unit (typical)

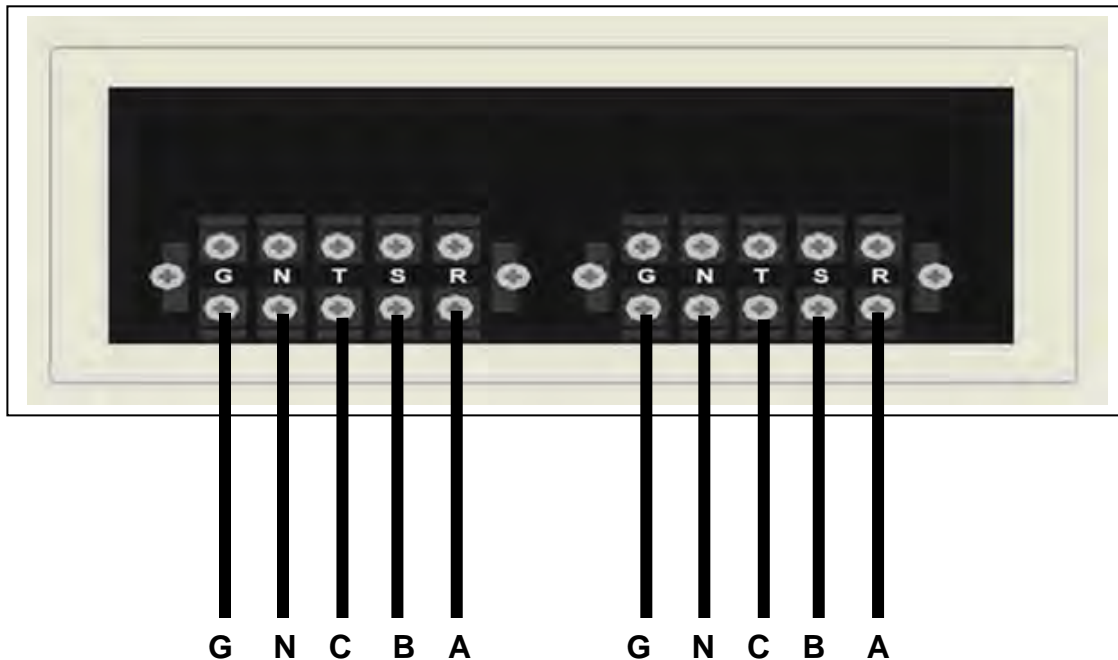

OUTPUT CONNECTIONS INPUT CONNECTIONS

NOTE: Terminal Phases R, S, T are North American (U.S.) A, B, C

NOTE: Other terminal configurations are possible. For example, there is no neutral terminal for delta-winding inputs. In addition, depending on voltage range, there may be no neutral terminal. And, although they provide 3-phase outputs, the APS-3003 and APS-3006 models have 1-phase inputs (2-wire plus ground).

WARNING

THIS EQUIPMENT CONTAINS HIGH ENERGY, LOW IMPEDANCE CIRCUITS!!
LETHAL POTENTIALS ARE CONTAINED WITHIN THE CABINET.
ONLY FULLY-QUALIFIED PERSONNEL SHOULD ATTEMPT TO MAKE INPUT
OR OUTPUT POWER CONNECTIONS.

Storage and Transportation

Packing Instructions

Please retain all the original packing materials. If the equipment must be sent back for repair, use the original packing materials for packing. Please contact the APS repair center or factory before returning equipment. Be sure to send all accessories and indicate the symptoms and cause of failure if known.

Other packing Material

If the original packing material is missing, please follow the instructions below:

- Wrap the equipment in PU (polyurethane) foam or Styrofoam.
- The equipment must be protected by shock-resistant material, about 70 to 100mm thick (3 to 4 inches).
- The front panel must be protected with cardboard.
- Secure packing tightly and insert unit into a wooden crate if possible.
- Label the box “fragile” and transport carefully.

Non-Operating Environment

The APS-3000 Series Frequency Converter can be stored and transported under the following environment:

- Temperature: $-40\text{ }^{\circ}\text{C} - 55\text{ }^{\circ}\text{C}$ ($-40\text{ }^{\circ}\text{F} - 131\text{ }^{\circ}\text{F}$)
- Altitude: 7,620 meters (25,000 feet)

Avoid sudden temperature changes. Sudden changes in temperature may result in condensation inside the equipment.

Chapter 2

Specifications

Chapter 2 - Specifications

Chapter 2 summarizes the capabilities and general features of the APS-3000 family of Power Converters. Functional capabilities are similar for all units. APS units convert fixed line voltage at a fixed frequency to user-selected 3-phase output voltages and frequencies. The primary differences between units are size, weight, and specific power handling capability. All units provide built-in PLC remote control for three programmable memories.

The Displays and Controls Table in this section provides summary information about the programmable memories and external control. More detailed information about external interface control is found in Chapter 5.

This Chapter includes five summary tables and a surge-current performance graph. The tables summarize different capabilities and features of APS-3000 Power Converters. The graph illustrates over-current (start-up surge-current) capabilities.

Introduction

APS-3000 Power Converters are rugged versatile workhorses. The intended location for APS-3000 units is the test floor, not a laboratory workbench. The smallest unit, the APS-3003, weighs 305 lbs. The largest unit, the APS3180, weighs around 4000 lbs. Users can select from several modes of operation:

- full-manual operation
- manually programmed operation
- remote PLC operation

In keeping with their workhorse nature, all APS-3000 units feature a 200% start-up surge-current capability. The ability to source initial surge currents prevents the programmed over-current protection from disabling a test.

APS-3000 Specifications

The following five tables and surge current graph provide detailed information about the entire family of APS-3000 Series of power converters.

- Input Electrical Specifications
- Output Electrical Specifications
- Displays and Controls
- Mechanical Specifications
- Environmental Specifications
- Surge-Current Rating Graph

Input Electrical Specifications											
Model	3003	3006	3009	3015	3030	3060	3090	3120	3150	3180	
Input Phase	1-phase/ 2-wire +			3-phase							
Input Voltage (VAC L/L)	230 V ± 15%			208, 220, 240(3-W+G) 380,415,480(4-W+G) ±10%							
Input Frequency	47 – 63 Hz										
Output Electrical Specifications											
Rated Power	Total Power	3 KVA	6 KVA	9	15KVA	30KVA	60KVA	90KVA	120KVA	150kVA	180kVA
	Per Phase	1 KVA	2 KVA	3 KVA	5 KVA	10KVA	20KVA	30KVA	40KVA	50kVA	60kVA
Max. Amps per phase	0 – 150 V	8.4 A	16.8 A	25.2 A	42.0 A	84.0 A	168.0	252.0	366.0A	417.0 A	500.0A
	0 – 300 V	4.2 A	8.4 A	12.6 A	21.0 A	42.0 A	84.0 A	126.0	168.0	208.0 A	250.0A
Phase	3-phase / 4-wire + Ground										
Voltage	Line to Neutral	0 – 150 V / 0 – 300 V Selectable									
	Line to Line	0 – 260 V / 0 – 520 V Selectable									
	Resolution	0.1 V									
	Accuracy	± (1% + 0.2 V)									
Frequency	Range	45 – 500 Hz									
	Resolution	0.1 Hz at 45 – 99.9 Hz, 1 Hz at 100 – 500 Hz									
	Accuracy	± 0.2%									
Per Phase Parameters		3003	3006	3009	3015	3030	3060	3090	3120	3150	3180
Current Per Phase	Range	L	0.000 – 3.5 A			0.00 – 35.00 A					
		H	3.00 – 35.00 A			30.00 – 350.0 A					
	Resolution	L	0.001 A			0.01 A					
		H	0.01 A			0.1 A					
	Accuracy	L	± (1% of reading +			± (1% of reading + 0.02 A)					
		H	± (1% of reading + 0.01			± (1% of reading + 0.1 A)					
Power Per Phase	Range	L	0.0 – 350.0 W			0.000 – 3.500 kW					
		H	300 – 4000 W			3.00 – 60.00 kW					
	Resolution	L	0.1 W			0.001 kW					
		H	1 W			0.01 kW					
	Accuracy	L	± (1.5% of reading +			± (1.5% of reading + 0.005 kW)					
		H	± (1.5% of reading +			± (1.5% of reading + 0.01 kW)					
Power Factor	Range	0.001 – 1.000									
	Resolution	0.001									
	Accuracy	Depends on the accuracy of V, A, W									
Harmonic Distortion	≤ 1% (Resistive Load)										
Crest Factor	≥ 3 to 1										
Load Regulation	± 0.5%										
Protection	Over-Current, Short-Circuit, Over-Temperature										
Efficiency	≥ 85% (at full load)										

Power versus Output Frequency Rating Chart

The following thermal ratings apply to models 3060, 3090, 3120, 3150 and 3180 as a function of load and programmed output frequency at an ambient temperature of 25°C. This derating is caused by heat build-up in the output transformer.

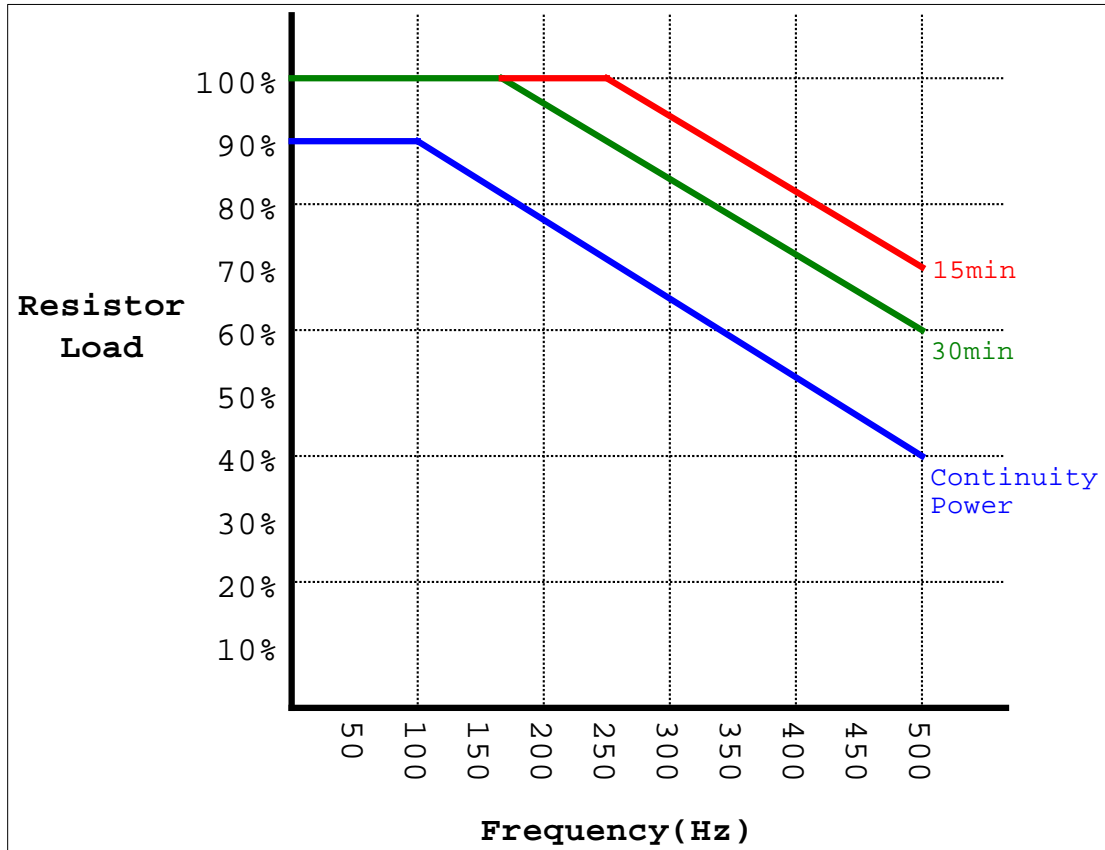

Output load ratings expressed as resistive load reflecting % of full load for frequency ranges at which the power source can operate continuously are as follows:

45Hz ~ 100Hz	90% resistive load
< 200Hz	77% resistive load
< 300Hz	65% resistor load
< 400Hz	52% resistor load
< 500Hz	40% resistor load

At an output frequency of 500Hz and output power into 70% resistor load, the power source can operate for a period of 15 minutes then instrument output will shut down because output transformer is too hot.

Displays and Controls

Model	3003	3006	3009	3015	3030	3060	3090	3120	3150	3180
4 Digital LED meters	Frequency, Voltage, Current, Power or Power Factor (simultaneously)									
PLC Remote	Output ON/OFF Selection of programmable memories: P1, P2, P3									
Memory	3 Memories, 5 Programmable Steps per Memory for: Voltage, Frequency, and Current Limit									
Calibration	Front Panel Calibration									
PLC (external) Interface	PLC interface controls execution of programmed steps in Memories 1, 2, or 3. The PLC interface is a standard feature of all APS Power Converters.									
Auto-Voltage Adjust	Provides improved voltage regulation									

Mechanical Specifications

Model	3003	3006	3009	3015	3030	3060	3090	3120	3150	3180
Power Rating (kVA)	3	6	9	15	30	60	90	120	150	180
Dimensions (In.):	H	34	34	34	34	38	62	71	71	71
	D	26	26	36	36	39	39	39	47	47
	W	17	17	24	24	24	35	48	48	63
Weight Kg		140	175	299	362	547	909	1505	2139	1800
	lbs	305	385	659	798	1206	2004	3318	4716	3968

Environmental Specifications

Operating Temperature	32 °F – 104 °F (0 °C – 40 °C)
Relative Humidity	< 80 % (Non-condensing)
Altitude	≤ 6,500 feet

Output Surge-Current Capability

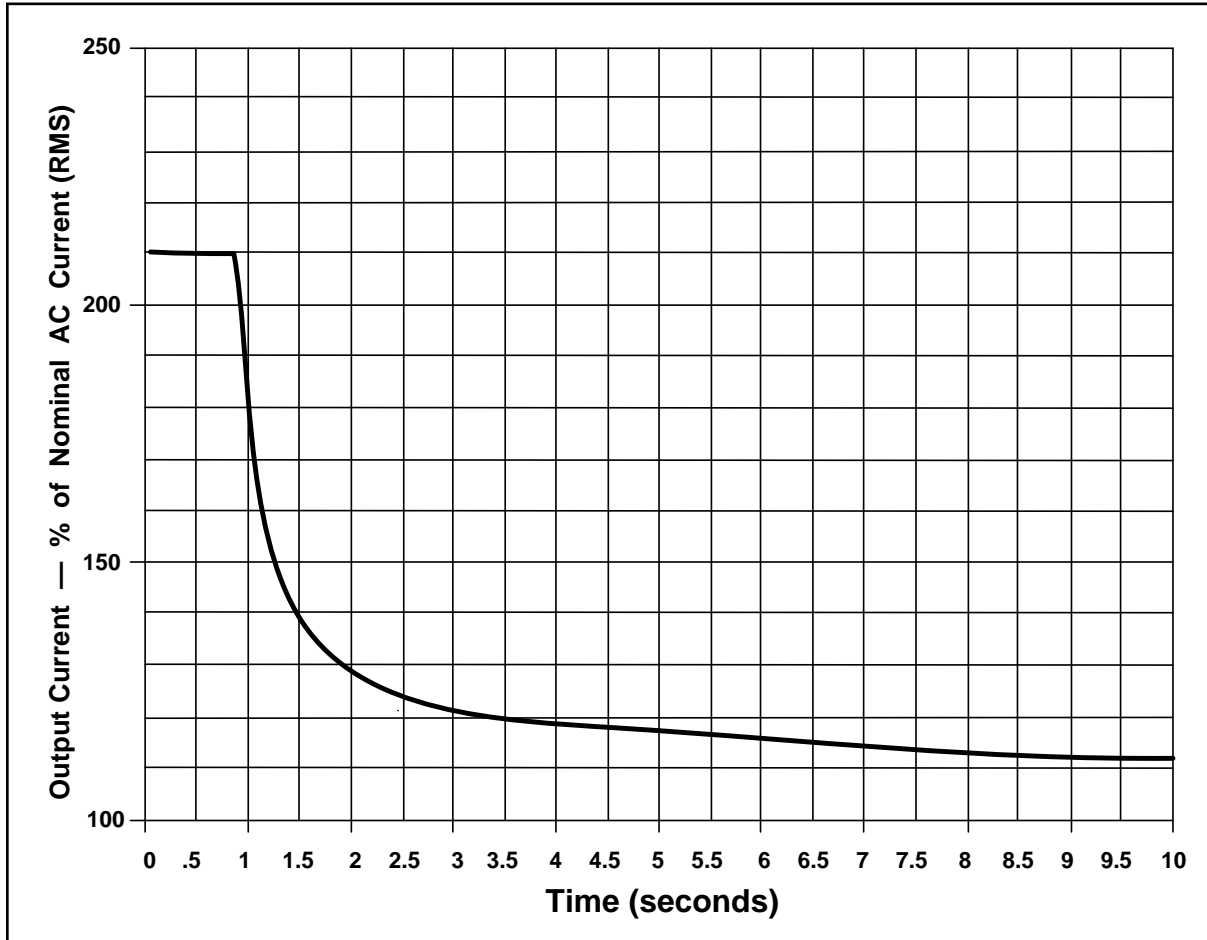

Output Surge-Current Rating

Rated Short-Term Overload Current vs. Time

Peak instantaneous current to approximately 200% of nominal AC RMS current is allowed. The actual operating time before thermal shutdown, or before the circuit breaker trips, will always vary. The exact time depends upon the temperature and line conditions.

Chapter 3

Unit Description

Chapter 3 – Unit Description

Chapter 3 helps you locate controls and understand their functions. More importantly, the names used throughout this manual to identify controls and functions are defined. You need to know the vocabulary of the APS-3000 Series to take full advantage of the information in this manual. Information in this chapter is in three sections:

- Location and function of front panel displays and controls
- Cabinet controls and connectors
- Chassis features and details

Use the information in this chapter to gain a general understanding of the locations and functionality of indicators, controls, connectors, and mechanical details of your APS-3000 unit.

Front Panel Organization

The front panel of your APS-3000 unit is organized for efficiency of operation. It is laid out to simplify operation in a test environment. The layout features:

- 4 Display Groups
 - Frequency Display
 - Voltage Display
 - Current Display
 - Multimeter Display
- 16 7-segment Display Indicators
- 16 Pushbutton Switches
- 20 LED Indicators

Front Panel of APS-3000 Series Power Converter

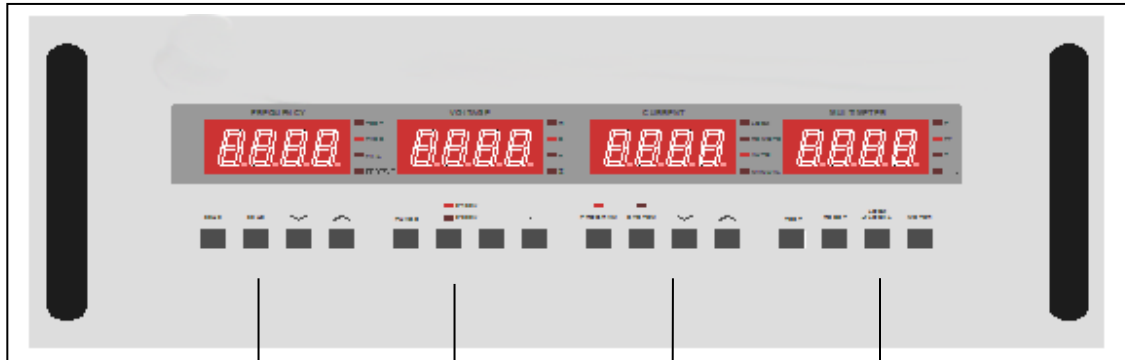

FREQUENCY

[] TEST
[] PASS
[] FAIL
[] PROTECT

50Hz [] 60Hz []

[] []

MULTIMETER

[] P
[] PF
[] T
[] P - S

TEST [] RESET [] LOCK /LOCAL [] METER []

VOLTAGE

[] R
[] S
[] T
[] Σ

PHASE [] []

0-150 [] 0-300 []

[] []

CURRENT

[] LOCK
[] REMOTE
[] AUTO
[] MANUAL

PROGRAM [] SYSTEM []

[] []

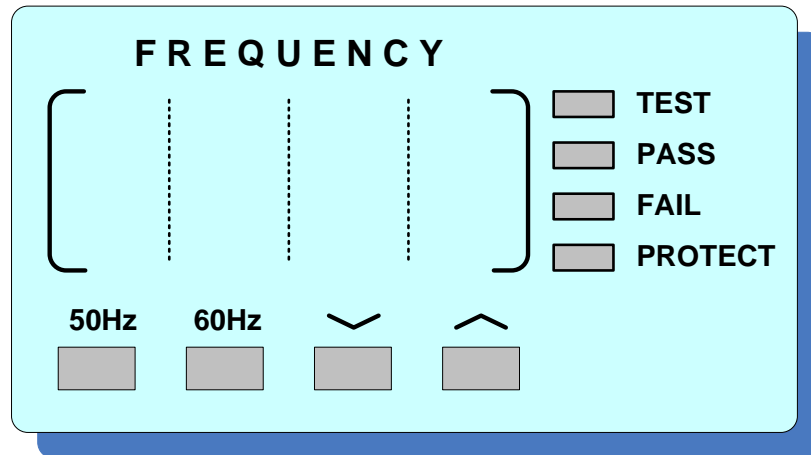

APS-3000 Frequency Display

Frequency Selection	
FREQUENCY display	Displays output frequency / defined frequency value, parameters during SYSTEM / PROGRAM set-up, and error messages under output error.
TEST indicator	When ON, the system is in normal power output operation.
PASS indicator	Not used for the APS-3000 Series
FAIL indicator	When ON, the system has encountered an output error.
PROTECT indicator	When ON, an output error has tripped the system protection circuit.
50 Hz button	Sets the output frequency to 50 Hz.
60 Hz button	Sets the output frequency to 60 Hz.
⌵ button	Steps the output frequency down to a minimum of 45 Hz.
⌶ button	Steps the output frequency up to a maximum of 500 Hz.

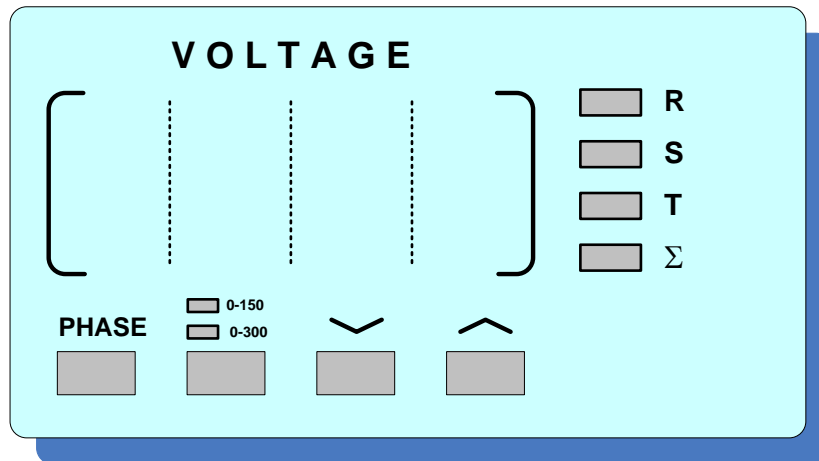

APS-3000 Voltage Display

Voltage Selection	
VOLTAGE display	Displays the output voltage / defined voltage value and parameters during the SYSTEM / PROGRAM set-up.
R indicator	When ON, the display indicates the R-phase output (A-phase in US).
S indicator	When ON, the display indicates the S-phase output (B-phase in US).
T indicator	When ON, the display indicates the T-phase output (C-phase in US).
Σ indicator	When ON, the display indicates the three-phase output.
PHASE button	Switches between the R / S / T / Σ phase display.
150 V indicator	When ON, the system is in low-voltage range (0 - 150 VAC).
300 V indicator	When ON, the system is in high-voltage range (0 - 300 VAC).
HIGH / LOW button	Located below the range indicators. Toggles between HIGH and LOW ranges.
⏏ button	Steps the output voltage down; SYSTEM / PROGRAM parameter select.
⏏ button	Steps the output voltage up; SYSTEM / PROGRAM parameter select.

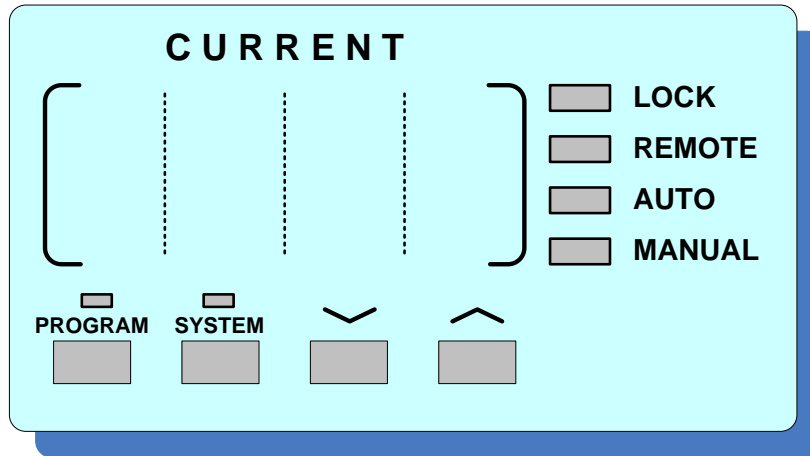

APS-3000 Current Display

Current Selection	
CURRENT display	Displays output current or the defined current value status and values during SYSTEM/PROGRAM set-up.
LOCK indicator	When ON, the panel is in a locked state; the buttons are deactivated.
REMOTE indicator	When ON, the system is controlled by rear panel external switching. =
AUTO indicator	Not used for the APS-3000 Series
MANUAL indicator	When ON, the system is in manual mode.
PROGRAM indicator	When ON, the PROGRAM parameter setting mode is active.
SYSTEM indicator	When ON, the SYSTEM parameter setting mode is active.
PROGRAM button	Enters / exits PROGRAM parameter set-up.
SYSTEM button	Enters / exits SYSTEM parameter set-up.
∨ button	Steps the current / SYSTEM / PROGRAM parameters value down; status select; and, sets current limit from 0.1 to system max.
∧ button	Steps the current / SYSTEM / PROGRAM parameters value up; status select; and, sets current limit from 0.1 to system max.

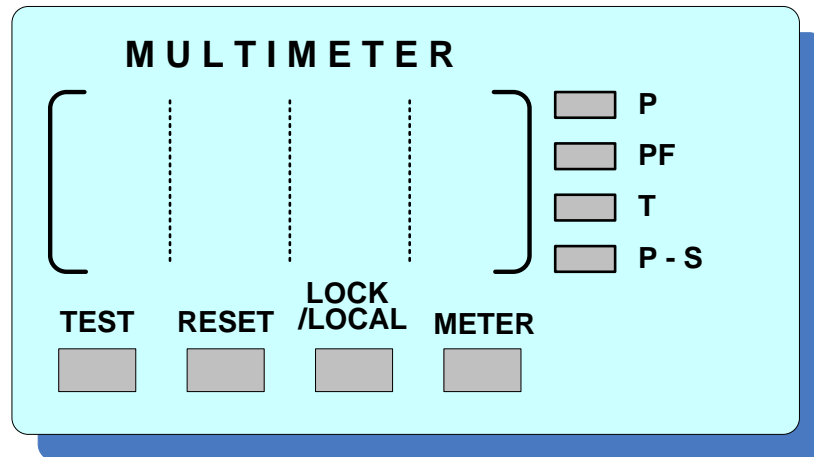

APS-3000 Multimeter Display

Multimeter Selection	
MULTIMETER display	Displays Power, Power Factor, Testing Time, or Program-Step.
P indicator	When ON, MULTIMETER displays output Power (kW).
PF indicator	When ON, MULTIMETER displays Power Factor.
T indicator	When ON, MULTIMETER displays Testing Time.
P-S indicator	When ON, MULTIMETER displays the current PROGRAM MEMORY status (index of Program-Step).
TEST button	Start output.
RESET button	Stop output.
LOCK / LOCAL button	Toggles between locked / unlocked state for the panel, using LOCAL button to leave the programmable mode.
METER button	Switches between the display of P (Power), PF (Power Factor), T (Testing Time), and P-S (Program-Step).

Cabinet Controls and Connections

The APS-3000 controls and connections are conveniently located for ease of use and accessibility. Included are:

- Power ON/OFF
- PLC Control Port
- Input Power Connection
- Input Power Circuit Breaker
- Output Power Connection
- Output Power Circuit Breaker

See the following page for illustrations. The Cabinet Controls Table on page 3-9 provides additional information about each of these items.

Chassis Details

The APS-3000 is built on a rugged chassis for use in demanding test environments. Important elements of the design include:

- Handles
- Wheels
- Fans
- Vents

See the following page for illustrations. The Chassis Details Table on page 3-9 provides additional information about each of these items.

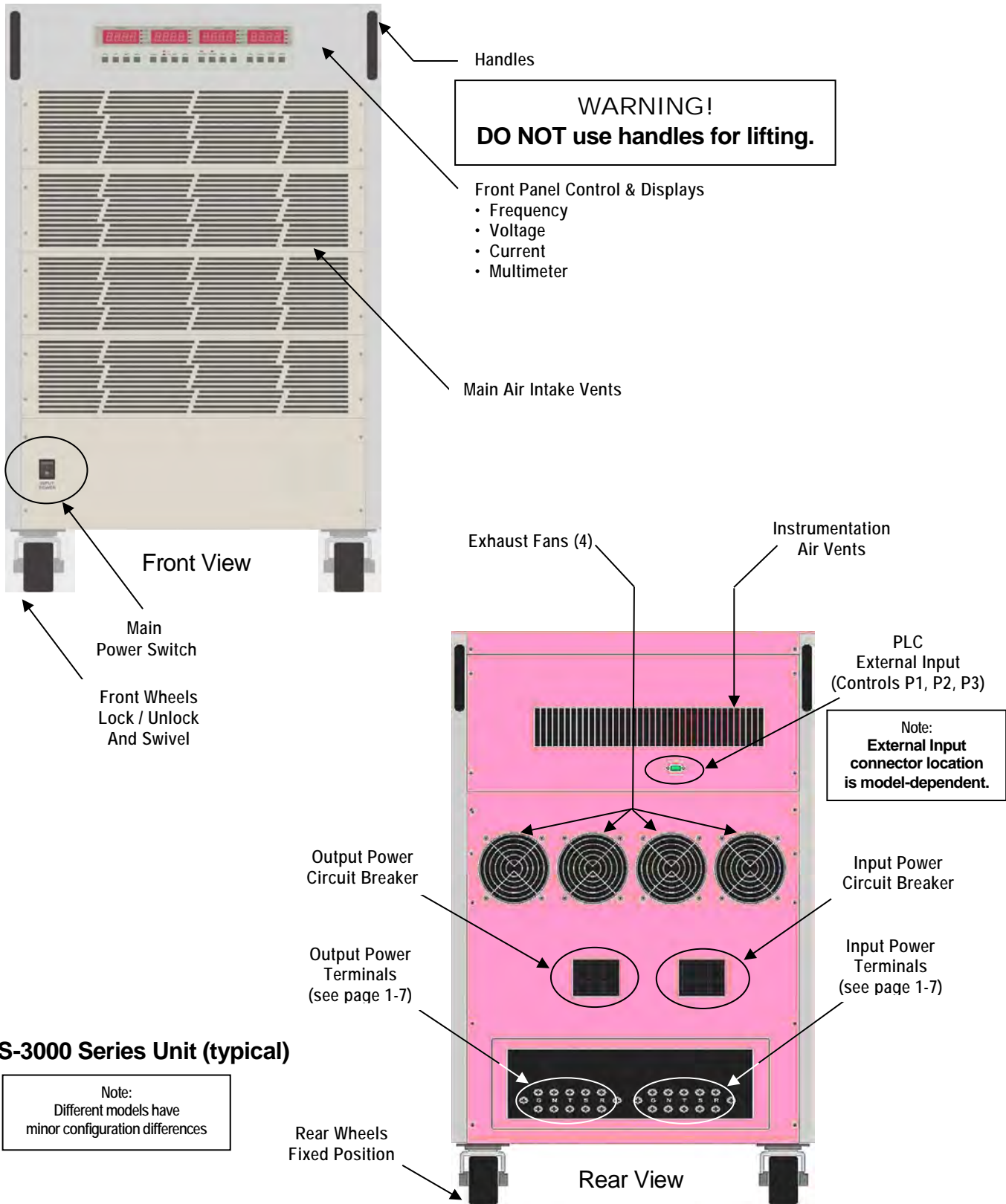

APS-3000 Series Unit (typical)

Note:
Different models have
minor configuration differences

Cabinet Features

CABINET CONTROLS	
Power ON / OFF	At the lower left side of the front of the unit. This is the main power switch that enables operation. NOTE: The unit is always in STANDBY mode when the Input Circuit Breaker is ON.
PLC Control Port	On the rear panel, DE-9 connector for external switchable selection and control of three stored programs; typically switched by a PLC. NOTE: DO NOT use this port for RS-232 or GPIB data and control.
Input Power Connection	The power input terminals are located at the lower right of the rear panel. The terminals are labeled "N" neutral; "G" Chassis / Earth Ground; and R, S, T for the power line phases (phases A, B, and C by North American convention).
Input Pwr Circuit Breaker	This is located just above the input power terminals
Output Power Connection	The power output terminals are located at the lower left of the rear panel. The terminals are labeled G -- Chassis / Earth Ground; N -- power neutral; and R, S, T for the power line phases (phases A, B, and C by North American convention).
Output Pwr Circuit Breaker	This is located just above the output power terminals.

CHASSIS DETAILS	
Handles	Located at the upper front and rear of the unit. These are mounted to the frame and may ONLY be used for moving the unit. In other words, the handles must NOT be used for lifting.
Wheels	The front wheels swivel for steering. They may be locked to prevent accidental movement. The rear wheels are fixed-direction only.
Fans and Vents	The unit draws air from front to back. Please keep the intake vents on the front and the fan exhausts on the rear clear of obstructions. Adequate cooling airflow is essential in maintaining proper operation.

Chapter 4

Operating Instructions

Chapter 4 – Operating Instructions

Use the instructions in Chapter 4 to set up your APS-3000 Power Converter so you can conduct tests. However, before attempting to set up your APS unit for testing, you should be familiar with the information provided in Chapters 1, 2, and 3.

APS suggests you decide on parameter values you wish to use before turning on the unit. There are many ways you can operate your unit. Consequently, you can begin getting acquainted with the APS-3000 Converter by NOT attaching a load. You can learn to select simple parameters by observing the front panel status displays.

After you are comfortable with your ability to enter operating parameters, you should power-down completely before connecting a test load.

The information in this chapter guides you through the process of first turning on the unit and verifying the configuration.

How Chapter 4 is Organized

Chapter 4 is organized into four sections. The information begins with what to expect when you power-up the unit. The sequence of information in these four sections is intended to make your use of the APS-3000 successful. The four sections are:

- Basic Operation
- System Parameter Settings
- Program Parameter Settings
- Error Messages

Basic Operation

System Information

When the power is turned ON, the front panel will momentarily display:

- The model number, in the VOLTAGE display
- The installed firmware version number, in the CURRENT display

Voltage Setting

When the system is in RESET (Standby) or TEST (Output ON) mode, press the VOLTAGE \wedge or \vee buttons to adjust the voltage value. There are two ranges: high and low. The high voltage range is 0 – 300V and the low range is 0 – 150V.

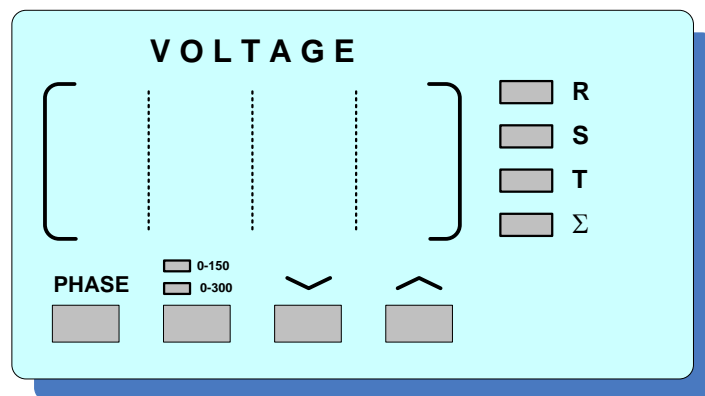

Pressing the \wedge or \vee voltage adjust buttons causes the value to increase/decrease one step every 0.3 seconds. Holding a button in causes the rate of change to accelerate. After a voltage adjustment has been completed, and the voltage selection remains unchanged for 2 seconds, the voltage display will flash once. The unit will memorize the current voltage setting. The system then exits the voltage-setting mode.

NOTE: If you have a series of tests, and any of those tests requires a voltage in excess of 150V, you must start your test sequence in the high voltage mode. The unit does not automatically switch from the 150V to the 300V range. Although the unit's rated maximum power is available in either voltage range, the maximum current in the 300V range is one-half that in the 150V range.

High/Low Output Voltage Range Setting

To switch between the high and low range, press the voltage range button (located beneath the 0 – 150V and 0 – 300V LEDs). In the low range, the voltage can be set between 0 – 150V. Available current capacity is higher, thus maintaining full power capacity. In the high voltage range, 0 – 300V, the current capacity is one-half (see Product Specifications, Chapter 2).

During TEST (Output ON), you can switch between high and low voltage modes. Switching between high/low voltage modes will not affect the voltage setting. However, there will be a brief interruption of the output (about 20 milliseconds), during the change.

If your test is unable to tolerate a 20 millisecond drop-out, you should not exercise this feature.

The system remembers your previously entered limit settings. Thus, the system will not accept a switching command which would direct operation outside the range limits. For example, if you specify a 200V lower voltage limit, the system will not allow you to switch to the low voltage (150V max) range.

Frequency Setting

When the system is in RESET (Standby) or TEST (Output ON) mode, press the FREQUENCY \wedge or \vee buttons to adjust the frequency value.

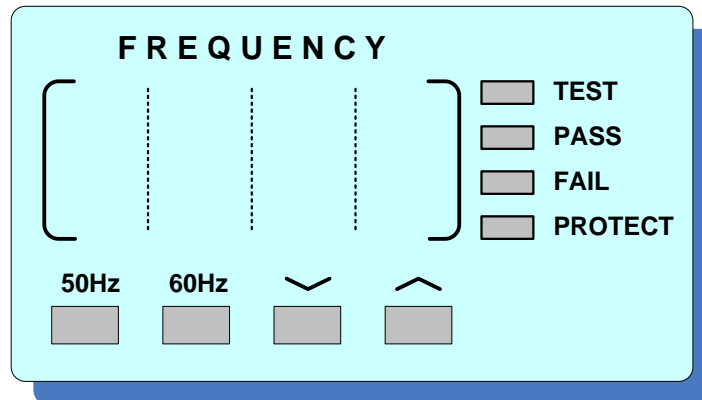

For frequencies between 45 – 99.9 Hz, the adjustment is 0.1 Hz per step. For frequencies between 100 Hz – 500 Hz, the adjustment is 1 Hz per step. However, pressing either the 50 Hz or 60 Hz buttons will cause 50 Hz or 60 Hz to be set immediately.

Pressing the \wedge or \vee frequency adjust buttons causes the value to increase/decrease one step every 0.3 seconds. Holding a button "in" forces the rate of change to accelerate. When the frequency selection remains unchanged for two seconds, the frequency display will flash once. The unit will memorize the current frequency setting. The system will then exit the frequency-setting mode.

Separate buttons are provided for 50 Hz and 60 Hz frequency settings. At any time you can press one of these buttons and the frequency will change from whatever it was to either 50 Hz or 60 Hz.

Note, if your unit shuts down due to a detected Error condition, the FREQUENCY display shows an abbreviation for that error. For example, an over-current condition will result in OCP being displayed. For a listing and discussion of all displayed error conditions, see the Error Messages section of this chapter.

Current Limit Setting

When the system is in RESET (Standby) or TEST (Output ON) mode, press the CURRENT \wedge or \vee buttons to display the preset Current Limit value.

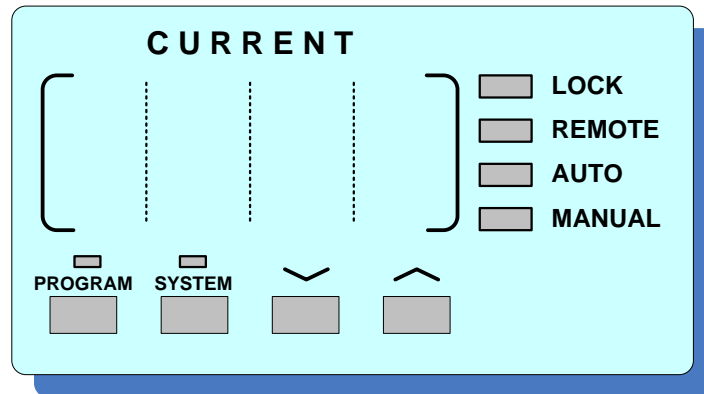

Press the \wedge or \vee buttons again to adjust the value. When unchanged for two seconds, the current limit adjustment terminates and the system returns to the previous setting interface. When the current limit value is OFF, the system will protect itself by limiting the current according to output capacity (see Specifications).

Note: If your unit shuts down due to a detected Over-Current condition, the FREQUENCY display shows OCP.

Multimeter

The active metering function will be indicated by the adjacent LEDs.

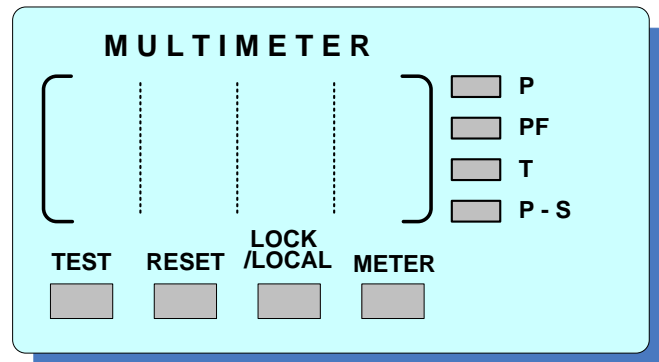

Press the METER button (on the MULTIMETER display) to scroll through Power (P), Power Factor (PF), Test Time (T), Program Set (P-S) displays. For example, P2-3 means third step of the second program-set.

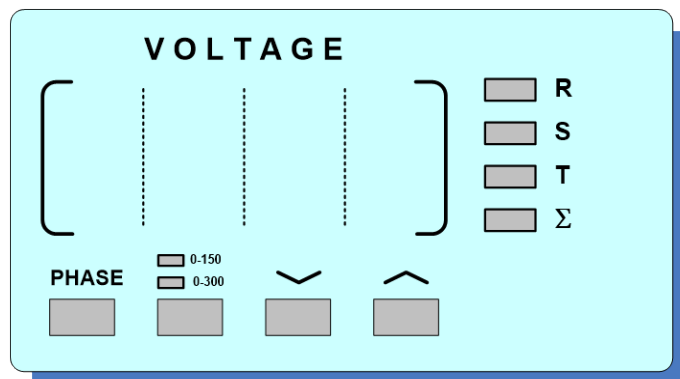

Press the PHASE button (on the VOLTAGE display) to scroll through phases R, S, and T, (North American phases A, B, and C) and Σ (combined) displays. The Σ readings are Average Line-to-Line Volts, Average Amps, Average Power Factor, and Total Power.

Start Output

BEFORE pressing the TEST button (on the MULTIMETER display), check to ensure every setting is correct. Press the TEST button to start the output. The TEST LED (on the FREQUENCY display) will light, indicating normal voltage output.

Stop Output

If a timed test has been initiated, the output will open when the preset testing time is reached. To manually stop a preset-time test, press the RESET button.

Press the RESET button to stop any test at any time.

Stop Alarm

When the system encounters an overload, short-circuit, over-temperature, over-current, or power/power-factor beyond the preset limit, the unit will shut down. Output power will turn off, and an alarm will sound. The FAIL LED (on the FREQUENCY display) will flash and the PROTECT LED (on the FREQUENCY display) will light (indicates over-load, short-circuit or over-temperature). Pressing the RESET button (on the MULTIMETER display) once will disable the alarm, pressing it again will reset the error message and return the unit to standby status.

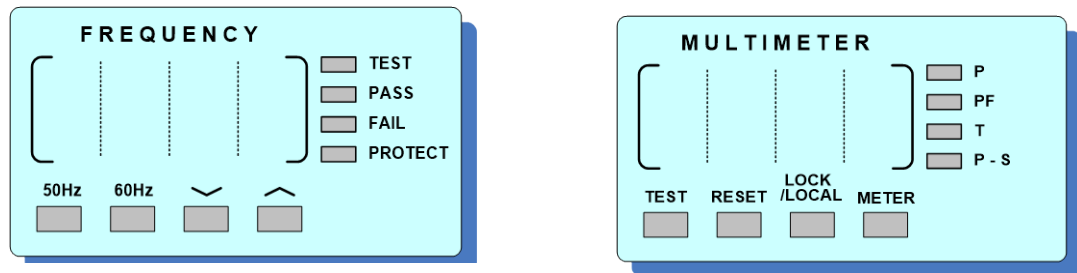

NOTE: Please determine the cause (source) of any alarm and correct the problem — before pressing TEST — to start the output again.

Lock Button

Pressing the LOCK/LOCAL button (on the MULTIMETER display) will light the LOCK LED (on the CURRENT display) and disable the other controls, except the METER button (on the MULTIMETER display). Pressing the LOCK/LOCAL button again unlocks the front panel. This procedure is used to avoid accidental adjustments to the system.

External Switching Control

You can attach a simple external switching controller, such as a PLC, to the 9-pin PLC D-sub connector on the rear panel. A PLC can be used to control the output ON/OFF or to switch between any of three pre-programmed control memories (P1, P2, or P3). Chapter 5 describes PLC operation.

NOTE: The PLC connector is NOT an input/output port for RS-232 serial data or for GPIB parallel data.

Programmed Memory Presets

When the unit is turned ON, you can push the PROGRAM button to set three programmed memory locations (P1, P2, or P3). You can adjust the voltage, frequency, and high-current limit for each program. After you have selected the control parameters for each program, push the PROGRAM button (again) to exit the Program Mode. See Page xx for program parameters and instructions.

System Parameter Settings

APS-3000 front panel displays are used to present status, test data, and system parameters. This is the normal mode of display during operation. A special operator-selected mode (described below) is entered when using the front panel displays for setting system parameters.

Entering the System Parameter Setting Mode

To enter the System Parameter Setting Mode, begin from the RESET (Standby) mode. Press the SYSTEM (on the CURRENT display) button. The SYSTEM LED (above the SYSTEM switch) lights up. System parameters are shown in the FREQUENCY and VOLTAGE displays. The present status and values are shown in the CURRENT display.

- Press the VOLTAGE \wedge or \vee buttons to select parameters for adjustment.
- Press the CURRENT \wedge or \vee buttons to set status and values for each item.

Sequence of System Parameters

The System Parameter items are presented in the following order:

- PLC Remote
- Auto Voltage Adjust
- Power-Up
- Frequency Hi-Limit
- Frequency Low-Limit
- Voltage Hi-Limit
- Voltage Low-Limit
- Over-Current Foldback

After the last item appears, the system will cycle back to the first item on the list. When you have finished, press SYSTEM (on the CURRENT Display), to exit the System Parameter Setting mode.

System Parameter Table

FREQUENCY DISPLAY	VOLTAGE DISPLAY	CURRENT DISPLAY	DESCRIPTION
	<i>PLC</i>	<i>OFF</i>	External Control / PLC Remote ON/OFF
	<i>PLC</i>	<i>On</i>	
<i>AUto</i>	<i>Adj</i>	<i>OFF</i>	Auto Voltage adjust function (AGC) enable / disable. When ON, output voltage regulation is improved.
<i>AUto</i>	<i>Adj</i>	<i>On</i>	
	<i>P-UP</i>	<i>OFF</i>	Power-Up output status
	<i>P-UP</i>	<i>On</i>	
	<i>P-UP</i>	<i>LAST</i>	
<i>FREQ</i>	<i>HI</i>	<i>500.0</i>	Maximum frequency setting limit
<i>FREQ</i>	<i>LO</i>	<i>45.0</i>	Minimum frequency setting limit
<i>Uolt</i>	<i>HI</i>	<i>300.0</i>	Maximum voltage setting limit
<i>Uolt</i>	<i>LO</i>	<i>0.0</i>	Minimum voltage setting limit
<i>CC</i>	<i>Fold</i>	<i>On</i>	Constant Current output mode, ON / OFF
<i>CC</i>	<i>Fold</i>	<i>OFF</i>	

Setting System Parameters (Programming)

Frequency Display	Voltage Display	Current Display
	<i>PLC</i>	<i>On / OFF</i>

PLC Remote. Press the CURRENT \wedge or \vee buttons to toggle the PLC ON / OFF in the current display.

- **OFF** The system is controlled directly from the front panel.
- **ON** The system is controlled by an external controller that is connected to the 9-PIN D-sub PLC connector on the rear panel.

Pressing any button on the front panel will cause the display to show PLC-ON, the buzzer to beep twice, and the display to return to RESET (Standby) mode. The LOCK / LOCAL, SYSTEM, and METER buttons are the only ones that will function when the PLC feature is ON.

NOTE: DO NOT use the PLC port for RS-232 serial or GPIB parallel data.

Frequency Display	Voltage Display	Current Display
<i>AUTO</i>	<i>Adj</i>	<i>On / OFF</i>

Auto Voltage Adjust. Press the CURRENT \wedge or \vee buttons to toggle ON / OFF. When ON, the automatic gain control circuit is activated and voltage regulation improves.

Frequency Display	Voltage Display	Current Display
	<i>P-UP</i>	<i>On / OFF / LAST</i>

Power Up. Press the CURRENT \wedge or \vee buttons to step the current display between OFF/ON/LASt.

- **OFF** The system will start in standby mode.
- **ON** The system will power up using the default output settings.
- **LAST** The system will power up using the output settings that were active when it was last shut down.

Frequency Display	Voltage Display	Current Display
<i>FrEq</i>	<i>HI</i>	<i>500.0</i>

Frequency Hi Limit. Press the CURRENT \wedge or \vee buttons to adjust the frequency limit value in the current display within the available range: 45.0 – 500.0 Hz. This value sets the upper frequency limit that can be adjusted during normal operation. The FrEq HI value must be higher than the FrEq LO value.

Frequency Display	Voltage Display	Current Display
FrEq	LO	45.0

Frequency Lo Limit. Press the CURRENT \wedge or \vee buttons to adjust the frequency limit value in the current display within the available range: 45.0 – 500.0 Hz. This value sets the lower frequency limit that can be adjusted during normal operation. The FrEq LO value must be lower than the FrEq HI value.

Frequency Display	Voltage Display	Current Display
Volt	HI	300.0

Voltage Hi Limit. Press the CURRENT \wedge or \vee buttons to adjust the voltage limit value in the current display within the available range: 0.0 – 300.0 V. This value sets the upper voltage limit that can be adjusted during normal operation. The Volt HI value must be higher than the Volt LO value.

Frequency Display	Voltage Display	Current Display
Volt	LO	0.0

Voltage Lo Limit. Press the CURRENT \wedge or \vee buttons to adjust the voltage limit value in the current display within the available range: 0.0 – 300.0 V. This value sets the lower voltage limit that can be adjusted during normal operation. The Volt LO value must be lower than the Volt HI value.

Frequency Display	Voltage Display	Current Display
OC	FOLD	On / OFF

Constant Current Output. Press the CURRENT \wedge or \vee buttons to toggle between ON/OFF.

- **OFF** The system will operate as a constant voltage power source only. If the load current exceeds the current high limit (A-HI), the unit will shut down.
- **ON** The system will limit the output current to a maximum value set by the current high limit (A-HI). For loads requiring less current than the A-HI value, the unit maintains a steady voltage output as set. If the load impedance is low enough, this function is activated when the load current attempts to exceed the current high limit (A-HI). The output current will then remain constant at the A-HI value and the output voltage will decrease accordingly.

Note: The parameter settings for current and power are described in the following section, Program Parameter Settings.

Program Parameter Settings

Use this procedures in this section to program the three memories: P1, P2, and P3. Each program will have three stored parameters: voltage, frequency, and current.

When the system is in RESET (Standby) mode, press the PROGRAM button to enter the Program Parameter setting mode. The PROGRAM parameter items are shown in the VOLTAGE display. The present status and values are shown in the CURRENT display

- Press the VOLTAGE \wedge or \vee buttons to select items for adjustment.
- Press the VOLTAGE \vee button to move to the next parameter item on the list.
- Press the CURRENT \wedge or \vee buttons to set the status and values for each item.

The Program Parameter items are presented in the following order:

- Program Selection from any combination of three programmable memories
- Output Voltage
- Output Frequency
- Current High Limit

After the last item appears, the system will cycle back to the first item on the list. When you have finished, press PROGRAM (on the CURRENT Display), to leave the Program Parameter Setting mode.

Program Parameter Table			
FREQUENCY DISPLAY	VOLTAGE DISPLAY	CURRENT DISPLAY	DESCRIPTION
	<i>Prog</i>	<i>1</i>	Program Number Selection (1, 2, or 3)
	<i>Volt</i>	<i>300</i>	Output voltage setting
	<i>FrEq</i>	<i>500.0</i>	Output frequency setting
	<i>A-HI</i>	<i>OFF</i>	Current (Amps) high limit
	<i>A-HI</i>	<i>00.00</i>	

Setting Program Parameters (Programming)

Frequency Display	Voltage Display	Current Display
	<i>Prog</i>	<i>1 to 3</i>

Program Number Selection. Press the CURRENT \wedge or \vee buttons to select one of the three program memory sets (P1 – P3). Each program memory can store up to five steps.

Frequency Display	Voltage Display	Current Display
	<i>Volt</i>	<i>300</i>

Output Voltage. Press the CURRENT \wedge or \vee buttons to set the voltage value in the range 0.0 – 300.0 V. If the voltage value exceeds 150V, the high voltage mode (0 – 300V) must be selected. When the system is in the RESET (Standby) state, adjusting the voltage value in the VOLTAGE display will also change the output voltage setting in the Program Step.

Frequency Display	Voltage Display	Current Display
	<i>Freq</i>	<i>500.0</i>

Output Frequency. Press the CURRENT \wedge or \vee buttons to set the frequency value in the range 45.0 – 500.0 Hz. When the system is in the RESET (Standby) state, adjusting the frequency value in the FREQUENCY display will also change the output frequency setting in the Program Step.

Frequency Display	Voltage Display	Current Display
	<i>A-HI</i>	<i>OFF / 00.00</i>

High Current Limit. Press the CURRENT \wedge or \vee buttons to select between OFF and 0.0 – nn.nn, the unit's nominal current. When set to OFF, there is no current high limit. When system is in RESET (Standby) status, pressing the CURRENT \wedge or \vee buttons will adjust the current high limit.

Error Messages

Why are there Errors?

Setup mistakes happen. Overloads occur. Systems under test fail. When the APS-3000 unit encounters a fault condition, an error has occurred. The result is:

- The front panel display presents a message.
- The output turns OFF.
- An alarm sounds.
- The “FAIL” LED flashes.
- The “PROTECT” LED lights

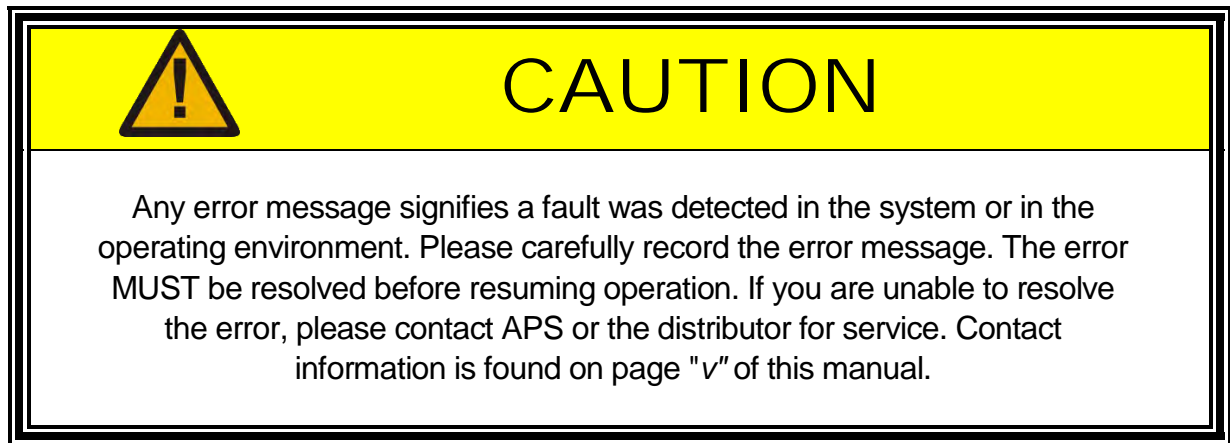

Clearing an Error

- Press RESET (once) to disable the alarm.
- Make a note of the error message.
- Re-read the CAUTION (above)
- Refer to following **Error Message Table**.
- Refer also to the more detailed explanation of error messages in the Error Message Section.
- Press RESET (again) to clear the error message and return to RESET (Standby) status.
- If you are unable to resolve the difficulty, please see page "v" of this manual for APS contact information.

Error messages are displayed because of the following conditions:

- Fail Under voltage occurred during startup
- OCP Output current exceeded 110% of units maximum-rated value
- Hi-A Output current exceeded the set current high limit value
- LoDC Inverter power supply voltage less than 80% of internal bus voltage
- HiDC Inverter power supply voltage greater than 120% of internal bus voltage
- AcLP Input power was interrupted and then resumed
- FUSE Fuse opened
- Igbt Insulated Gate Bipolar Transistor (IGBT) overloaded
- OtP System's critical temperature was exceeded
- OVP Output voltage was high
- LVP Output voltage was low
- OPP Output power was high

Error Message Table

FREQUENCY DISPLAY	VOLTAGE DISPLAY	CURRENT DISPLAY	DESCRIPTION
	<i>FAIL</i>		Inverter power supply Under-voltage occurred during startup
<i>OCP</i>			Output current exceeded 110% of maximum rated value
<i>HI - A</i>			Output current exceeded set current high-limit value
<i>Lodc</i>			Inverter power supply voltage was less than 80% of the rated internal bus voltage
<i>HI dc</i>			Inverter power supply voltage was greater than 120% of the rated internal bus voltage
<i>AcLP</i>			Input power was interrupted and then resumed
<i>FUSE</i>			Fuse opened
<i>IGBT</i>			Insulated Gate Bipolar Transistor (IGBT) overloaded
<i>OTP</i>			System's critical temperature was exceeded
<i>OVP</i>			Output voltage exceeded limit
<i>LVP</i>			Output voltage below limit
<i>OPP</i>			Output power exceeded limit

Interpreting Error Messages



Under-Voltage Occurred During Startup. During power up, if the inverter voltage does not reach the specified level, the VOLTAGE display will show FAIL, an alarm will sound, and all buttons will be disabled. Turn off the input power to reset the message.



Output Current Exceeded 110%. If the output current exceeds 110% of the set value, the FREQUENCY display will show OCP (Over Current Protect); an alarm will sound; the FAIL LED will flash; the PROTECT LED will light; and the VOLTAGE and CURRENT displays will show the corresponding values at the time of overload.

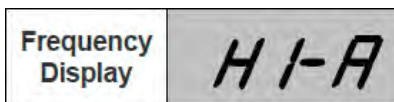

Output Current Exceeded Hi-A Limit. If the output current exceeds the set current high limit value, the FREQUENCY display will show HI-A; an alarm will sound; the FAIL LED will flash; and the VOLTAGE and CURRENT displays will show the corresponding values at the time of overload.



Inverter Power Supply Voltage Below Operating Range. If the inverter power supply voltage is less than 80% of the input voltage, the FREQUENCY display will show Lodc (Low DC voltage). This means the INVERTER supply voltage is less than the normal working range for the APS-3000. An alarm will sound; the FAIL LED will flash; the PROTECT LED will light; and the VOLTAGE and CURRENT displays will show their corresponding values.

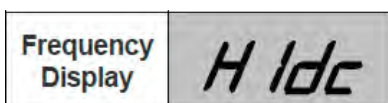

Inverter Power Supply Voltage Exceeded Operating Range. If the inverter power supply voltage is greater than 120% of the input voltage, the FREQUENCY display will show HIdc (Hi DC voltage). This means the INVERTER supply voltage is greater than the normal working range for the APS-3000. An alarm will sound; the FAIL LED will flash; the PROTECT LED will light; and the VOLTAGE and CURRENT displays will show their corresponding values.



AC Power Momentarily Interrupted. If the input power is interrupted and then resumed, the FREQUENCY display will show AcLP (AC Line Power). This signifies a power abnormality. An alarm will sound; the FAIL LED will flash; the PROTECT LED will light; and the VOLTAGE and CURRENT displays will show their corresponding values.



Blown Fuse. If a fuse opens, the FREQUENCY display will show FUSE. This means the internal bus was overloaded. An alarm will sound; the FAIL LED will flash; the PROTECT LED will light; and the VOLTAGE and CURRENT displays will show their corresponding values.



Insulated Gate Bipolar Transistor Overloaded. If an insulated gate bipolar transistor (IGBT) is overloaded, the FREQUENCY display will show Igbt. The Insulated gate bipolar transistors are the main power transistors in the power conversion circuit. An alarm will sound; the FAIL LED will flash; the PROTECT LED will light; and the VOLTAGE and CURRENT displays will show their corresponding values.

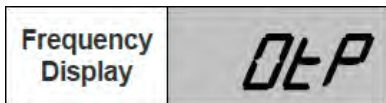

System Critical Temperature Exceeded. If any of the system's critical temperatures are exceeded, the FREQUENCY display will show OtP (Over temperature Protect). This signifies overheating. An alarm will sound; the FAIL LED will flash; the PROTECT LED will light; and the VOLTAGE and CURRENT displays will show their corresponding values.



Output Voltage Limit Exceeded. If the output voltage exceeds the voltage setting by more than 5V on the 0-150V range or 10V on the 0-300V range, the FREQUENCY display will show OVP (Over Voltage Protect); an alarm will sound; the FAIL LED will flash; the PROTECT LED will light; and the VOLTAGE and CURRENT displays will show the corresponding values at the time of over-voltage.



Output Voltage Below Limit. If the output voltage is lower than the voltage setting by more than 5V on the 0-150V range or 10V on the 0-300V range, the FREQUENCY display will show LVP (Underr Voltage Protect); an alarm will sound; the FAIL LED will flash; the PROTECT LED will light; and the VOLTAGE and CURRENT displays will show the corresponding values at the time of over-voltage.



Output Power Limit Exceeded. If the output power exceeds 125% of the rated output for 0.3 seconds or 110% of the rated output for 1.0 seconds the FREQUENCY display will show OPP (Over Power Protect); an alarm will sound; the OUTPUT/RESET LED will flash; and the VOLTAGE and CURRENT displays will show the corresponding values at the time of over-power.

Chapter 5

External Interface

Chapter 5 – External Interface

This chapter provides information about the three types of APS-3000 external interfaces. Use the information in Chapter 5 to take advantage of the remote control and / or data acquisition capabilities of your unit. You will probably find that test operations controlled from the front panel are relatively intuitive. However, external control of testing requires understanding the detailed commands and data structures provided in this chapter.

PLC External Interface

All APS Power Converters have a built-in PLC External Interface. Consequently, all APS Power Converters can be operated remotely. The PLC external interface is particularly useful for tests that require the use of independent metering and external data acquisition instrumentation. The PLC external interface allows remotely located contact closures to start / stop one of three test programs. These test programs are located in memory sets P1, P2, and P3.

Operation of the PLC remote interface does not require a true PLC, as simple switch closures are effective at starting and stopping a stored test program. However, although simple switches can be used, they require manual operation. The use of a PLC permits external automatic control of the test programs in memories P1, P2, or P3.

The APS PLC internal circuitry is activated by first setting the system parameter PLC to ON. In addition, you must connect an external switch / controller. The controller is attached using the PLC External Interface D-Sub DE-9 connector located on the rear panel of your APS-3000 Power Converter (see page 3-8).

NOTE: The PLC D-Sub DE-9 connector is NOT an RS-232 or GPIB data connector.

When the PLC system parameter is set to ON in the Systems parameters, the TEST button on the front panel is disabled. If the TEST button is pressed, PLC ON will be displayed on the panel, an alarm will sound, and the system will return to its previous status. If the system encounters an error, the front panel RESET button or the ON/OFF control at the PLC remote can be enabled to perform a system reset.

A sketch of the APS PLC DE-9 pinouts and simple switch configuration is shown on the following page.

Manual Switched (Three-Program Control)

The user can build a simple switch circuit to operate the PLC interface. Use the following information to build a cable and switch-box. The Sync input circuitry shown below is not required for this switch box approach.

DE-9	Item	Comments
2	+ 12 VDC	Low Power, Current Limited
3 to 5	SPST Switch	ON/OFF Dry Contact
4	Vcc Sync	Sync Input Opto Bias Voltage
5 to 8	SPST, NO	P1 Momentary, Dry Contact
5 to 9	SPST, NO	P2 Momentary, Dry Contact
5 to 8 and 9	SPST, NO	P3 Momentary, Dry Contact
6	Common	Sync Input Opto Bias Common
8 and 9	Diodes (+ side)	1N4148 or 1N914, etc.

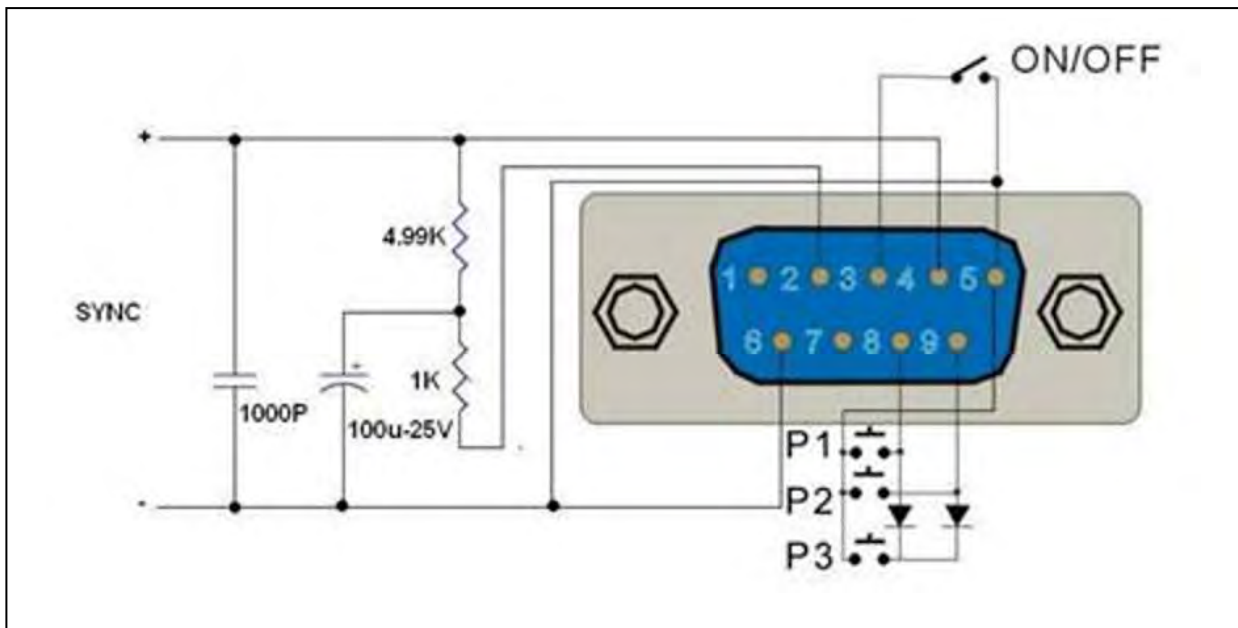

PLC DE-9 Connector and Control

Chapter 6

System Calibration

Chapter 6 – System Calibration

Chapter 6 explains how to calibrate your APS-3000 Series Power Converter. Although each APS unit is carefully calibrated at the factory prior to shipment., periodic calibration is appropriate. Normal system maintenance requires calibration once a year (See Chapters 7).

Whether you perform calibration prior to a critical test or as a scheduled annual maintenance task, the procedures for calibration are identical.

Note, the values of some calibration parameters are different for different sizes of APS models. This chapter includes tables of all calibration parameters for all models. Please use the calibration values that are for your particular model.

APS-3000 Series Calibrations Modes

Six separate procedures are provided for the six calibration modes. Because this is a 3-phase system, calibration is necessary for each phase.

- Low-voltage mode (*U-LD*) calibration:
- High-voltage mode (*U-HI*) calibration:
- Low-current mode (*A-LD*) calibration:
- High-current mode (*A-HI*) calibration:
- Low-power mode (*P-LD*) calibration:
- High-power mode (*P-HI*) calibration:

Each of the six calibration modes is explained in a separate section. As necessary, sections contain calibration parameters relative to that calibration mode.

Calibration Setup

APS-3000 calibration is straightforward. However, you must use the appropriate calibration instrumentation and test fixtures. In addition to test cables and connectors, you will need:

- RMS Voltmeter, $\pm 0.2\%$, capable of at least 300 VAC
- RMS Ammeter, $\pm 0.2\%$, (See Calibration Settings Table for your APS model)
- Resistive Load Bank, Calculated for your APS model (See following Example)

How to Calculate the Size of the Test Load (Example)

For an example, suppose your system is an APS3030.

The High Current Calibration Procedure (later in this chapter) specifies an output voltage of 100 VAC, for all models. From the Table of Calibration Settings, you see the A HI (A) calibration test current for the (example) APS3030 is specified at 80 A per phase.



CALIBRATION SETTINGS										
Parameter	3003	3006	3009	3015P	3030	3060	3090	3120	3150	3180
V LO (VAC)	150.0	150.0	150.0	150.0	150.0	150.0	150.0	150.0	150.0	150.0
V HI (VAC)	300.0	300.0	300.0	300.0	300.0	300.0	300.0	300.0	300.0	300.0
A LO (A)	3.000	3.000	3.000	30.00	30.00	30.00	30.00	30.00	30.00	30.00
A HI (A)	8.000	16.00	25.00	42.00	80.00	160.0	250.0	330.0	400.0	480.0
P LO (kW)	0.3000	0.3000	0.3000	3.000	3.000	3.000	3.000	3.000	3.000	3.000
P HI (kW)	1.000	2.000	3.000	5.000	9.000	18.00	27.00	36.00	45.00	54.00

For 100 VAC and 80 A, each leg of your 3- phase load bank should have a resistance of

$$R = \frac{V_{rms}}{I_{rms}} = \frac{120 \text{ volts}}{80 \text{ amps}} = 1.50 \text{ ohms.}$$

The power handling capability of each resistive leg of the test load must be at least

$$P = \frac{(V_{rms})^2}{R} = \frac{(120 \text{ volts})^2}{1.50 \text{ ohms}} = 9600 \text{ watts} = 9.6 \text{ kW.}$$



WARNING

**THIS EQUIPMENT CONTAINS HIGH ENERGY, LOW IMPEDANCE CIRCUITS!!
LETHAL POTENTIALS ARE CONTAINED WITHIN THE CABINET.**

**CARE MUST BE EXERCISED WHEN OPERATING, CALIBRATING, OR SERVICING
THIS EQUIPMENT, IN ORDER TO PREVENT SERIOUS OPERATOR INJURY OR
EQUIPMENT DAMAGE.**

OBSERVE THE FOLLOWING WHEN SERVICE AND MAINTENANCE ARE REQUIRED:

- 1) REMOVE ALL JEWELRY FROM ARMS AND NECK WHEN
SERVICING THIS EQUIPMENT. THIS PREVENTS THE
POSSIBILITY OF SHORTING THROUGH THE JEWELRY AND
CAUSING BURNS TO THE OPERATOR.**
- 2) WEAR SAFETY GLASSES WHEN SERVICING THIS EQUIPMENT TO PREVENT EYE
INJURY DUE TO FLYING PARTICLES CAUSED BY ACCIDENTAL SHORT CIRCUIT
CONDITIONS.**
- 3) DO NOT REMOVE ANY PANEL OR COVER WITHOUT FIRST REMOVING THE INPUT
POWER BY OPENING ALL CIRCUIT BREAKERS.**
- 4) SERVICE OTHER THAN REGULARLY SCHEDULED CALIBRATION OR EXTERNAL
CLEANING SHOULD BE REFERRED TO PERSONNEL AUTHORIZED BY THE
FACTORY TO SERVICE THIS EQUIPMENT.**

Calibration Instructions

General Information about Calibration

- At the MULTIMETER Display, pressing the RESET button aborts the calibration process.
- Your APS unit identifies power phase R, S, and T. These three phases are equivalent to the North American Phases A, B, and C.
- The system must be restarted after all calibration operations have been completed.

Entering the Calibration Mode

- At the Multimeter Display, press and continue to hold the LOCK / LOCAL button while turning the power on.
- After about 2 seconds, the unit will execute the calibration program that is appropriate for your particular unit, based on the APS model number. The Frequency Display will display CAL and the Voltage Display will display the model number. XY corresponds to the model number and nominal power rating of your unit.

Frequency Display	Voltage Display
CAL	30 XY

→

OUTPUT ELECTRICAL SPECIFICATIONS											
Model: 3 0 X Y		3003	3006	3009	3015	3030	3060	3090	3120	3150	3180
Rated Pwr	Total kVA	3	6	9	15	30	60	90	120	150	180
	Per Phase	1kVA	2kVA	3kVA	5kVA	10kVA	20kVA	30kVA	40kVA	50kVA	60kVA
Max. Amps per phase	0 – 150 V	8.4A	16.8A	25.2A	42.0A	84.0A	168A	252A	336A	420A	500A
	0 – 300 V	4.2A	8.4A	12.6A	21.0A	42.0A	84A	126A	168A	210A	250A

- Confirm the displayed model number agrees with your unit's model number. The internal calibration program uses this model number in its activities.
- If there is disagreement between the displayed model number and unit's actual model number, you should stop the process, turn off the unit, and contact your distributor or the factory. Please refer to page "v" of this manual for factory contact information.

Selecting Calibration Parameters

- Following the controlled power-up, your APS unit enters the Low Voltage (*U-LD*) calibration mode. The calibration sequence will always begin at phase R. Upon completion of Phase R calibration, pressing FREQUENCY \curvearrowright will begin the calibration sequence for phase S; then, again for phase T.
- Phase R is equivalent to North American Phase A
- Phase S is equivalent to North American Phase B
- Phase T is equivalent to North American Phase C
- Press the FREQUENCY \curvearrowright or \curvearrowleft buttons to select the system parameter you are going to calibrate.
- Pressing FREQUENCY \curvearrowright proceeds to the next calibration mode. Pressing FREQUENCY \curvearrowleft returns to the previous step.
- Low-voltage mode (*U-LD*) calibration
- High-voltage mode (*U-HI*) calibration
- Low-current mode (*A-LD*) calibration
- High-current mode (*A-HI*) calibration
- Low-power mode (*P-LD*) calibration
- High-power mode (*P-HI*) calibration

Calibration Frequency

Please note, the calibration frequency is internally selected to be 60 Hz. Consequently, there is no user-selectable calibration frequency setting. Please use resistive loads for all of your load-calibration procedures. Resistive loads are not sensitive to frequency.

Low-Voltage Mode (U-LO) Calibration

1. At the FREQUENCY Display, press the \wedge or \vee buttons to select *U-LO* (V-LO). The low-voltage parameter is calibrated (first) at the beginning of calibration.
2. At the OUTPUT Terminals, with no load attached, carefully connect a certified, calibrated True RMS voltmeter, of at least 0.2% accuracy, to the output of Phase R (US = A) and Neutral (N). After calibrating Phase R, you will repeat this step for Phases S and T.
3. At the MULTIMETER Display, press the TEST button. The APS unit will automatically perform a low-voltage output reading and will output approximately 150 VAC. The external RMS voltmeter will display the actual voltage output, and the current display will show the calibration value (see Calibration Table below).

Frequency Display	Voltage Display	Current Display
<i>U-LO</i>	<i>150.0</i>	<i>150.0</i>

CALIBRATION SETTINGS										
Parameter	3003	3006	3009	3015P	3030	3060	3090	3120	3150	3180
V LO (VAC)	150.0	150.0	150.0	150.0	150.0	150.0	150.0	150.0	150.0	150.0
V HI (VAC)	300.0	300.0	300.0	300.0	300.0	300.0	300.0	300.0	300.0	300.0
A LO (A)	3.000	3.000	3.000	30.00	30.00	30.00	30.00	30.00	30.00	30.00
A HI (A)	8.000	16.00	25.00	42.00	80.00	160.0	250.0	330.0	400.0	480.0
P LO (kW)	0.3000	0.3000	0.3000	3.000	3.000	3.000	3.000	3.000	3.000	3.000
P HI (kW)	1.000	2.000	3.000	5.000	9.000	18.00	27.00	36.00	45.00	54.00

4. At the CURRENT Display Adjust the voltage using the CURRENT \wedge or \vee buttons until the metered values match.
5. At the Multimeter Display, press the LOCK button to finish low-voltage calibration.
6. Proceed to the next calibration function, unless this completes system calibration.
7. Note, to exit the Calibration Mode, your APS system must be restarted after you have completed ALL calibration operations.

High-Voltage Mode (U-HI) Calibration

1. At the FREQUENCY Display, press the \sim buttons to select *U-HI* (V-HI). The high-voltage parameter is calibrated after you calibrate the low voltage.
2. At the OUTPUT Terminals, with no load attached, carefully connect a certified, calibrated True RMS voltmeter, of at least 0.2% accuracy, to the output of Phase R (US = A) and Neutral (N). After calibrating Phase R, you will repeat this step for Phases S and T.
3. At the MULTIMETER Display, press the TEST button. The APS unit will automatically perform a high-voltage output reading and will output approximately 300 VAC. The external RMS voltmeter will display the actual voltage output. The CURRENT Display shows the calibration value (See Calibration Table, below).

Frequency Display	Voltage Display	Current Display
<i>U-HI</i>	<i>300.0</i>	<i>300.0</i>

CALIBRATION SETTINGS										
Parameter	3003	3006	3009	3015P	3030	3060	3090	3120	3150	3180
V LO (VAC)	150.0	150.0	150.0	150.0	150.0	150.0	150.0	150.0	150.0	150.0
V HI (VAC)	300.0	300.0	300.0	300.0	300.0	300.0	300.0	300.0	300.0	300.0
A LO (A)	3.000	3.000	3.000	30.00	30.00	30.00	30.00	30.00	30.00	30.00
A HI (A)	8.000	16.00	25.00	42.00	80.00	160.0	250.0	330.0	400.0	480.0
P LO (kW)	0.3000	0.3000	0.3000	3.000	3.000	3.000	3.000	3.000	3.000	3.000
P HI (kW)	1.000	2.000	3.000	5.000	9.000	18.00	27.00	36.00	45.00	54.00

4. At the CURRENT Display, adjust the voltage using the CURRENT \wedge or \vee buttons until the metered values match.
5. At the Multimeter Display, press the LOCK button to finish high-voltage calibration.
6. Proceed to the next calibration function, unless this completes system calibration.
7. Note, to exit the Calibration Mode, your APS system must be restarted after you have completed ALL calibration operations.

Low-Current (A-LO) Mode Calibration

1. At the FREQUENCY Display, press the \vee button to select **A-LO** (A LO).
2. At the OUTPUT Terminals, carefully connect a resistive load and connect a certified, calibrated True RMS ammeter, of at least 0.2% accuracy, to Phase R (US = A). After you calibrate Phase R, you will repeat this step for Phases S and T.
3. The size of the resistive load should be calculated based on the low-current parameter for your particular APS unit, as shown in the following Calibration Settings Table. Use 120 VAC for the voltage.
4. An example calculation is shown on page 6-2 in the Section *Calculation Setup*, subsection *How to Calculate the Size of the Load*.

CALIBRATION SETTINGS										
Parameter	3003	3006	3009	3015P	3030	3060	3090	3120	3150	3180
V LO (VAC)	150.0	150.0	150.0	150.0	150.0	150.0	150.0	150.0	150.0	150.0
V HI (VAC)	300.0	300.0	300.0	300.0	300.0	300.0	300.0	300.0	300.0	300.0
A LO (A)	3.000	3.000	3.000	30.00	30.00	30.00	30.00	30.00	30.00	30.00
A HI (A)	8.000	16.00	25.00	42.00	80.00	160.0	250.0	330.0	400.0	480.0
P LO (kW)	0.3000	0.3000	0.3000	3.000	3.000	3.000	3.000	3.000	3.000	3.000
P HI (kW)	1.000	2.000	3.000	5.000	9.000	18.00	27.00	36.00	45.00	54.00



5. At the MULTIMETER Display, press the TEST button. The APS unit will automatically perform a low-current output reading and will output approximately 120 VAC.
6. The external RMS ammeter will display the actual current output. The CURRENT Display shows the calibration value (see Calibration Table, above).

Frequency Display	Voltage Display	Current Display
A-LO	120.0	30.00

7. Adjust the load or the output voltage until the RMS ammeter displays the value shown in the Calibration Table (above). Please note, the value for your unit will depend on the model.
8. At the CURRENT Display, adjust the metered current using the \wedge or \vee buttons until the metered values match.

9. At the Multimeter Display, press the LOCK button to complete low-current calibration.
10. Proceed to the next calibration function, unless this completes system calibration.
11. Note, to exit the Calibration Mode, your APS system must be restarted after you have completed ALL calibration operations.

High Current (A-HI) Mode Calibration

1. At the FREQUENCY Display, press the \vee button to select **A-HI** (A HI).
2. At the OUTPUT Terminals, carefully connect a resistive load and connect a certified, calibrated True RMS ammeter, of at least 0.2% accuracy, to Phase R (US = A). After you calibrate Phase R, you will repeat this step for Phases S and T.
3. The size of the resistive load should be calculated based on the high-current parameter for your particular APS unit, as shown in the following Calibration Table. Use 120 VAC for the voltage.
4. An example calculation is shown on page 6-2 in the Section *Calculation Setup*, subsection *How to Calculate the Size of the Load*.

CALIBRATION SETTINGS										
Parameter	3003	3006	3009	3015P	3030	3060	3090	3120	3150	3180
V LO (VAC)	150.0	150.0	150.0	150.0	150.0	150.0	150.0	150.0	150.0	150.0
V HI (VAC)	300.0	300.0	300.0	300.0	300.0	300.0	300.0	300.0	300.0	300.0
A LO (A)	3.000	3.000	3.000	30.00	30.00	30.00	30.00	30.00	30.00	30.00
A HI (A)	8.000	16.00	25.00	42.00	80.00	160.0	250.0	330.0	400.0	480.0
P LO (kW)	0.3000	0.3000	0.3000	3.000	3.000	3.000	3.000	3.000	3.000	3.000
P HI (kW)	1.000	2.000	3.000	5.000	9.000	18.00	27.00	36.00	45.00	54.00



5. At the MULTIMETER Display, press the TEST button. The APS unit will automatically perform a high-current output reading and will output approximately 120VAC.
6. The external RMS ammeter will display the actual current output. The CURRENT Display shows the calibration value (see Calibration Table, above).

Frequency Display	Voltage Display	Current Display
A-HI	120.0	80.00

7. Adjust the load or the output voltage until the RMS ammeter displays the value shown in the Calibration Table (above). Please note, the value for your unit will depend on the model.
8. At the CURRENT Display, adjust the metered current using the \wedge or \vee buttons until the metered values match.

9. At the Multimeter Display, press the LOCK button to complete high-current calibration.
10. Proceed to the next calibration function, unless this completes system calibration.
11. Note, to exit the Calibration Mode, your APS system must be restarted after you have completed ALL calibration operations.

Low-Power (P-LO) Mode Calibration

1. At the FREQUENCY Display, press the \vee button to select *P-LO* (P LO).
2. At the OUTPUT Terminals, carefully connect a resistive load and connect a certified, calibrated RMS power meter, of at least 0.2% accuracy, to Phase R (US = A). After you calibrate Phase R, you will repeat this step for Phases S and T.
3. The size of the load should be calculated based on the low-current parameter for your particular APS unit, as shown in the following Calibration Table. Use 120 VAC for the voltage.
4. An example calculation is shown on page 6-2 in the Section *Calculation Setup*, subsection *How to Calculate the Size of the Load*.

CALIBRATION SETTINGS										
Parameter	3003	3006	3009	3015P	3030	3060	3090	3120	3150	3180
V LO (VAC)	150.0	150.0	150.0	150.0	150.0	150.0	150.0	150.0	150.0	150.0
V HI (VAC)	300.0	300.0	300.0	300.0	300.0	300.0	300.0	300.0	300.0	300.0
A LO (A)	3.000	3.000	3.000	30.00	30.00	30.00	30.00	30.00	30.00	30.00
A HI (A)	8.000	16.00	25.00	42.00	80.00	160.0	250.0	330.0	400.0	480.0
P LO (kW)	0.3000	0.3000	0.3000	3.000	3.000	3.000	3.000	3.000	3.000	3.000
P HI (kW)	1.000	2.000	3.000	5.000	9.000	18.00	27.00	36.00	45.00	54.00



5. At the MULTIMETER Display, press the TEST button. The APS unit will automatically perform a low-power output reading and will output approximately 120VAC.
6. The external RMS power meter will display the actual power output. The CURRENT Display shows the calibration value (see Calibration Table, above).

Frequency Display	Voltage Display	Current Display
<i>P-LO</i>	<i>120.0</i>	<i>3.00</i>

7. Adjust the load or the output voltage until the RMS power meter displays the value shown in the Calibration Table (above). Please note, the value for your unit will depend on the model.
8. At the CURRENT Display, adjust the metered power using the \wedge or \vee buttons until the metered values match.

9. At the Multimeter Display, press the LOCK button to complete low-power calibration.
10. Proceed to the next calibration function, unless this completes system calibration.
11. Note, to exit the Calibration Mode, your APS system must be restarted after you have completed ALL calibration operations.

High-Power (P-HI) Mode Calibration

1. At the FREQUENCY Display, press the \vee button to select *P-HI* (P HI).
2. At the OUTPUT Terminals, carefully connect a resistive load and connect a certified, calibrated RMS power meter, of at least 0.2% accuracy, to Phase R (US = A). After you calibrate Phase R, you will repeat this step for Phases S and T.
3. The size the load should be calculated based on the high-current parameter for your particular APS unit, as shown in the following Calibration Table. Use 120VAC for the voltage.
4. An example calculation is shown on page 6-2 in the Section *Calculation Setup*, subsection *How to Calculate the Size of the Load*.

CALIBRATION SETTINGS										
Parameter	3003	3006	3009	3015P	3030	3060	3090	3120	3150	3180
V LO (VAC)	150.0	150.0	150.0	150.0	150.0	150.0	150.0	150.0	150.0	150.0
V HI (VAC)	300.0	300.0	300.0	300.0	300.0	300.0	300.0	300.0	300.0	300.0
A LO (A)	3.000	3.000	3.000	30.00	30.00	30.00	30.00	30.00	30.00	30.00
A HI (A)	8.000	16.00	25.00	42.00	80.00	160.0	250.0	330.0	400.0	480.0
P LO (kW)	0.3000	0.3000	0.3000	3.000	3.000	3.000	3.000	3.000	3.000	3.000
P HI (kW)	1.000	2.000	3.000	5.000	9.000	18.00	27.00	36.00	45.00	54.00



5. At the MULTIMETER Display, press the TEST button. The APS unit will automatically perform a high-power output reading and will output approximately 120 VAC.
6. The external RMS power meter will display the actual power output. The CURRENT Display shows the calibration value (see Calibration Table, above).

Frequency Display	Voltage Display	Current Display
<i>P-HI</i>	<i>120.0</i>	<i>9.00</i>

7. Adjust the load or the output voltage until the RMS power meter displays the value shown in the Calibration Table (above). Please note, the value for your unit will depend on the model.
8. At the CURRENT Display, adjust the metered power using the \wedge or \vee buttons until the metered values match.
9. At the Multimeter Display, press the LOCK button to complete high-power calibration.

10. Proceed to the next calibration function, unless this completes system calibration.
11. Note, to exit the Calibration Mode, your APS system must be restarted after you have completed ALL calibration operations.

Chapter 7

System Maintenance

Chapter 7 – System Maintenance

Chapter 7 describes the maintenance procedures you should perform. This is a very short chapter because, other than keeping air filters clean, there is almost no user maintenance required.

Introduction

No internal parts require user maintenance. If the equipment appears to have a malfunction, please contact APS or the distributor for service (see page "v"). The wiring and block diagram are for reference only.

Scheduled Maintenance

The APS-3000 Series Frequency Converters should be inspected and calibrated once per year to ensure safety and accuracy of the equipment. Air vents must be kept clear of obstructions. If the equipment is used on a regular basis in a dusty environment, more frequent cleaning may be necessary.

The exterior of the unit should be cleaned with a damp cloth or sponge.

Interior cleaning should be limited to vacuuming or blowing with clean dry air to remove accumulated dust.



Modification

Do not modify this equipment. Any modifications void the warranty automatically, and violate the tested safety standards of the unit. APS does not take responsibility for such equipment. Parts or accessories not certified by APS will not be covered under the warranty. If any modification is detected in equipment returned for service, the equipment will be returned immediately by APS and the customer will be charged for this inspection / service.

System Design

APS-3000 Series power converters are high power Pulse Width Modulated (PWM) switching amplifiers. The internal switching frequency is 10 kHz. This frequency is 200 times higher than the lowest operating frequency (50 Hz) and 20 times higher than the highest operating frequency (500 Hz). The choice of switching frequency provides high resolution and ensures removal of high frequency harmonics. The all-digital control circuitry meters and displays system outputs, in addition to generating control signals. The system is microprocessor-based. Firmware in a proprietary EEPROM allows APS-configuration upgrades.



WARNING

**THIS EQUIPMENT CONTAINS HIGH ENERGY, LOW IMPEDANCE CIRCUITS!!
LETHAL POTENTIALS ARE CONTAINED WITHIN THE CABINET.**

**CARE MUST BE EXERCISED WHEN SERVICING THIS EQUIPMENT
IN ORDER TO PREVENT SERIOUS OPERATOR INJURY OR EQUIPMENT DAMAGE.**

OBSERVE THE FOLLOWING --- WHEN SERVICE AND MAINTENANCE ARE REQUIRED:

- **REMOVE ALL JEWELRY FROM ARMS AND NECK WHEN SERVICING THIS EQUIPMENT. THIS PREVENTS THE POSSIBILITY OF SHORTING THROUGH THE JEWELRY AND CAUSING BURNS TO THE OPERATOR.**
- **WEAR SAFETY GLASSES WHEN SERVICING THIS EQUIPMENT TO PREVENT EYE INJURY DUE TO FLYING PARTICLES CAUSED BY ACCIDENTAL SHORT CIRCUIT CONDITIONS.**
- **DO NOT REMOVE ANY PANEL OR COVER WITHOUT FIRST REMOVING THE INPUT POWER BY OPENING ALL CIRCUIT BREAKERS.**
- **SERVICE OTHER THAN EXTERNAL CLEANING SHOULD BE REFERRED TO PERSONNEL AUTHORIZED BY THE FACTORY TO SERVICE THIS EQUIPMENT. THERE ARE NO USER-SERVICABLE INTERNAL PARTS.**

System Block Diagram

If you are interested in how the APS-3000 works, you can learn more by reviewing the System Block Diagram on the following page. Please note, the block diagram is supplied for information purposes only. There are no serviceable components available to the user.

APS-3000 Series Block Diagram

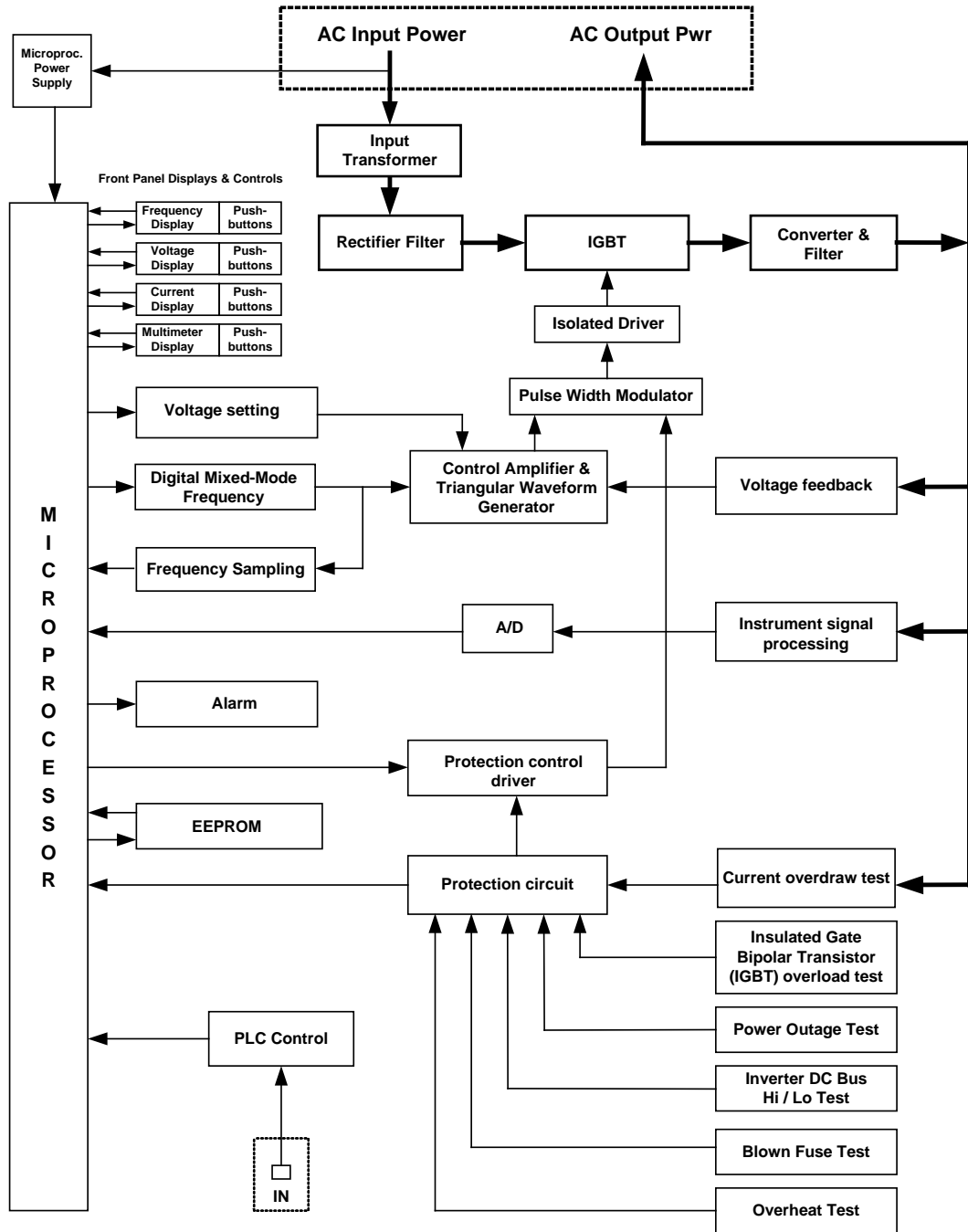

APS-3000 Series System Block Diagram